

SP RELAYS

2 Form C 15 A, 4 Form C 10 A, Polarized power relays

Protective construction : Dust cover type

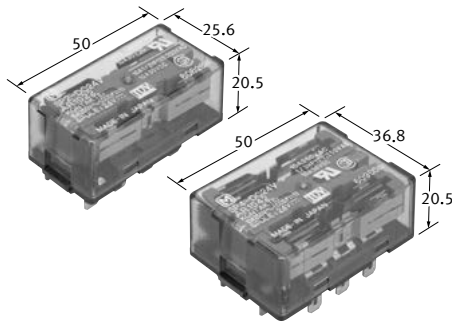

(Unit : mm)

FEATURES

- High sensitivity: Rated operating power 300 mW
- Plug-in terminal/PC board terminal
- Latching types also available
- Mounts directly on chassis and the mounting board is also available to enable DIN rail installation
- Terminal sockets are available

ORDERING INFORMATION (PART NO. : Ordering part number for Japanese market)

AR 1

- Terminal shape · Operating function
 - 0 : Plug-in type, Single side stable
 - 1 : Plug-in type, 1 coil latching*
 - 2 : Plug-in type, 1 coil latching
 - 3 : PC board type, Single side stable*
 - 4 : PC board type, 1 coil latching*
 - 5 : PC board type, 2 coil latching*
- Contact arrangement
 - 2 : 2 Form C
 - 4 : 4 Form C
- Rated coil voltage (DC)

Part No.	0	1	2	3	8	9
Rated coil voltage (V)	6	12	24	48	3	5

*PC board type and 1 coil latching type are manufactured by lot upon receipt of order.

ORDERING INFORMATION (TYPE NO. : Ordering part number for non Japanese market)

SP

- SP - [] - [] - [] - []
- Contact arrangement
 - 2 : 2 Form C
 - 4 : 4 Form C
 - Terminal shape
 - Nil : Plug-in type
 - P : PC board type
 - Operating function
 - Nil : Single side stable
 - L : 1 coil latching
 - L2 : 2 coil latching
 - Rated coil voltage (DC)
 - 3, 5, 6, 12, 24, 48V

Notes : 1. PC board type and 1 coil latching type are manufactured by lot upon receipt of order.
2. Certified by UL, CSA and TÜV

Power relays (Over 2 A) SP RELAYS

TYPES

" Type No. " is ordering part number for non Japanese market. " Part No. " is ordering part number for Japanese market.

Contact arrangement	Rated coil voltage	Single side stable		2 coil latching		Standard packing	
		Type No.	Part No.	Type No.	Part No.	Inner carton	Outer carton
2 Form C	3 V DC	SP2-DC3V	AR1028	SP2-L2-DC3V	AR1228	20 pcs.	200 pcs.
	5 V DC	SP2-DC5V	AR1029	SP2-L2-DC5V	AR1229		
	6 V DC	SP2-DC6V	AR1020	SP2-L2-DC6V	AR1220		
	12 V DC	SP2-DC12V	AR1021	SP2-L2-DC12V	AR1221		
	24 V DC	SP2-DC24V	AR1022	SP2-L2-DC24V	AR1222		
	48 V DC	SP2-DC48V	AR1023	SP2-L2-DC48V	AR1223		
4 Form C	3 V DC	SP4-DC3V	AR1048	SP4-L2-DC3V	AR1248	10 pcs.	100 pcs.
	5 V DC	SP4-DC5V	AR1049	SP4-L2-DC5V	AR1249		
	6 V DC	SP4-DC6V	AR1040	SP4-L2-DC6V	AR1240		
	12 V DC	SP4-DC12V	AR1041	SP4-L2-DC12V	AR1241		
	24 V DC	SP4-DC24V	AR1042	SP4-L2-DC24V	AR1242		
	48 V DC	SP4-DC48V	AR1043	SP4-L2-DC48V	AR1243		

For the terminal sockets, please refer to the "SP RELAYS Terminal sockets". For the mounting board, please refer to the "SP RELAYS Mounting board".

RATING

Coil data

- Operating characteristics such as 'Operate voltage' and 'Release voltage' are influenced by mounting conditions, ambient temperature, etc.

Therefore, please use the relay within $\pm 5\%$ of rated coil voltage.

- 'Initial' means the condition of products at the time of delivery.

Single side stable

Rated coil voltage	Operate voltage* (at 20°C)	Release voltage* (at 20°C)	Rated operating current ($\pm 10\%$, at 20°C)	Coil resistance ($\pm 10\%$, at 20°C)	Rated operating power	Max. allowable voltage (at 20°C)
3 V DC	Max. 70% V of rated coil voltage (Initial)	Min. 10% V of rated coil voltage (Initial)	100 mA	30 Ω	300 mW	150% V of rated coil voltage
5 V DC			60.2 mA	83 Ω		
6 V DC			50 mA	120 Ω		
12 V DC			25 mA	480 Ω		
24 V DC			12.5 mA	1,920 Ω		
48 V DC			6.2 mA	7,700 Ω		

*square, pulse drive

2 coil latching

Rated coil voltage	Set voltage* (at 20°C)	Reset voltage* (at 20°C)	Rated operating current ($\pm 10\%$, at 20°C)		Coil resistance ($\pm 10\%$, at 20°C)		Rated operating power		Max. allowable voltage (at 20°C)
			Set coil	Reset coil	Set coil	Reset coil	Set coil	Reset coil	
3 V DC	Max. 70% V of rated coil voltage (Initial)	Max. 70% V of rated coil voltage (Initial)	100 mA	100 mA	30 Ω	30 Ω	300 mW	300 mW	150% V of rated coil voltage
5 V DC			60.2 mA	60.2 mA	83 Ω	83 Ω			
6 V DC			50 mA	50 mA	120 Ω	120 Ω			
12 V DC			25 mA	25 mA	480 Ω	480 Ω			
24 V DC			12.5 mA	12.5 mA	1,920 Ω	1,920 Ω			
48 V DC			6.2 mA	6.2 mA	7,680 Ω	7,680 Ω			

*square, pulse drive

Specifications

Item		Specifications	
Contact data	Contact arrangement	2 Form C	4 Form C
	Contact resistance (initial)	Max. 30 mΩ (by voltage drop 6 V DC 1 A)	
	Contact material	Stationary contact: Au flashed AgSnO ₂ type, Movable contact: AgSnO ₂ type	
	Contact rating (resistive)	15 A 250 V AC, 10 A 30 V DC	10 A 250 V AC, 10 A 30 V DC
	Max. switching power (resistive)	3,750 VA, 300 W	2,500 VA, 300 W
	Max. switching voltage	250 V AC, 30 V DC (48 V DC: Max. 2 A)	
	Max. switching current	15 A (AC), 10 A (DC)	10 A (AC), 10 A (DC)
	Min. switching load (reference value)*1	100 mA 5 V DC	
Insulation resistance (initial)		Min. 1,000 MΩ (at 500 V DC, Measured portion is the same as the case of dielectric strength.)	
Dielectric strength (initial)	Between open contacts	1,500 V AC for 1 min (detection current: 10 mA)	
	Between contact sets	3,000 V AC for 1 min (detection current: 10 mA)	
	Between contact and coil	3,000 V AC for 1 min (detection current: 10 mA)	
Time characteristics (initial)	Operate (Set) time	Max. 30 ms (Min. 30 ms) at rated coil voltage (at 20°C, without bounce)	
	Release (Reset) time	Min. 20 ms (Min. 30 ms) at rated coil voltage (at 20°C, without bounce, without diode)	
Shock resistance	Functional	392 m/s ² (half-sine shock pulse: 11 ms, detection time: 10 μs)	
	Destructive	980 m/s ² (half-sine shock pulse: 6 ms)	
Vibration resistance	Functional	10 to 55 Hz (at double amplitude of 3 mm, detection time: 10 μs)	
	Destructive	10 to 55 Hz (at double amplitude of 3 mm)	
Expected life	Mechanical life	Min. 50 × 10 ⁶ (switching frequency: 180 times/min)	
Conditions	Conditions for usage, transport and storage*2	Ambient temperature: -50 to +60°C, Humidity: 5 to 85% RH (Avoid icing and condensation)	
Unit weight		Approx. 50 g	Approx. 65 g

*1. This value can change due to the switching frequency, environmental conditions, and desired reliability level, therefore it is recommended to check this with the actual load.

*2. For ambient temperature, please read "GUIDELINES FOR RELAY USAGE".

Expected electrical life

Conditions: Resistive load, switching frequency 20 times/min

Type	Switching capacity	Number of operations
2 Form C	15 A 250 V AC	Min. 100 × 10 ³
	10 A 30 V DC	Min. 100 × 10 ³
4 Form C	10 A 250 V AC	Min. 100 × 10 ³
	10 A 30 V DC	Min. 100 × 10 ³

Power relays (Over 2 A) SP RELAYS

REFERENCE DATA

1-1.Coil temperature characteristics (2 Form C)

Tested sample : SP2-24V DC

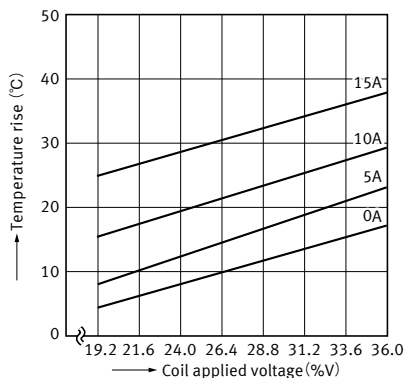

1-2.Coil temperature characteristics (4 Form C)

Tested sample : SP4-24V DC
Ambient temperature : 27 to 29°C

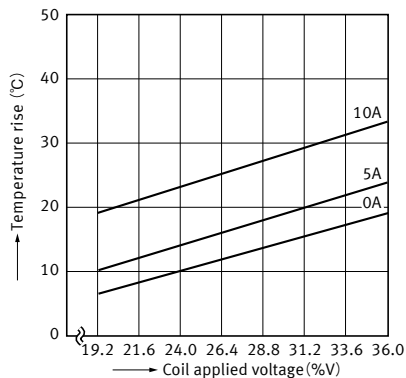

2-1.Electrical life test (2 Form C, 15 A 250 V AC Resistive load)

Change of operate and release voltage

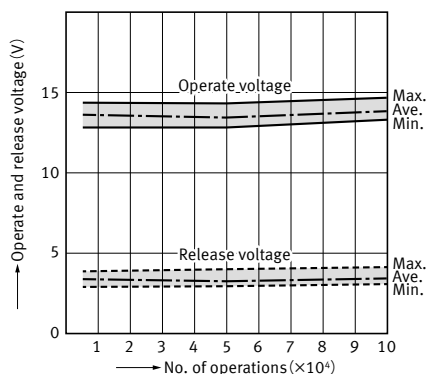

Change of contact resistance

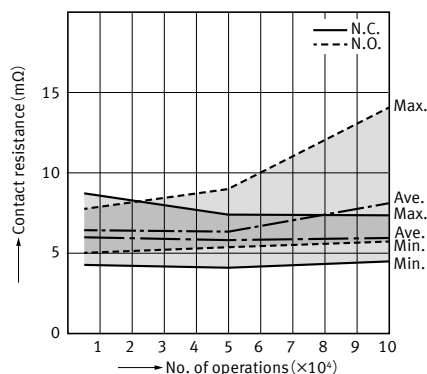

2-2.Electrical life test (4 Form C, 10 A 250 V AC Resistive load)

Change of operate and release voltage

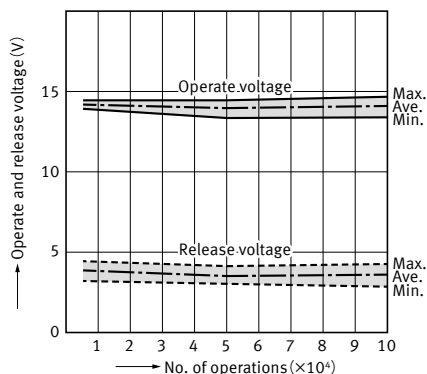

Change of contact resistance

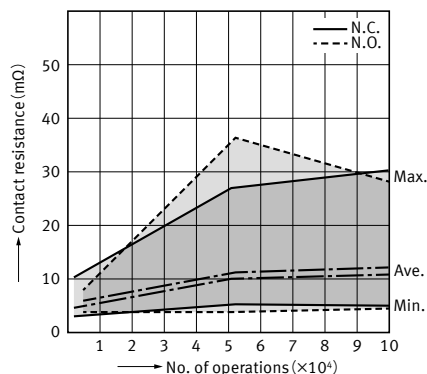

DIMENSIONS

CAD The CAD data of the products with a "CAD" mark can be downloaded from our Website.

Unit: mm

■ 2 Form C

● Plug-in terminal

CAD

External dimensions

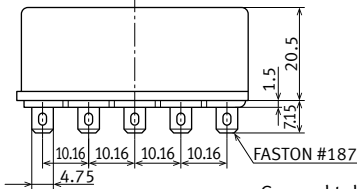
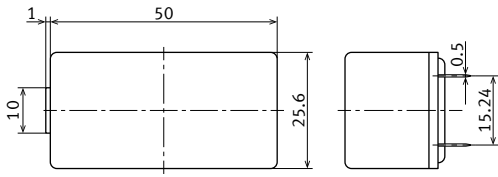

General tolerance ± 0.3

● PC board terminal

CAD

External dimensions

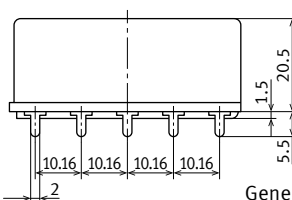
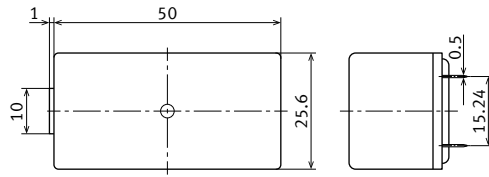

General tolerance ± 0.3

Recommended PC board pattern (BOTTOM VIEW)

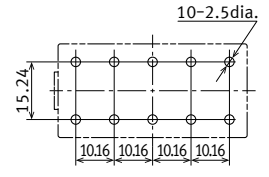

Tolerance ± 0.1

Schematic (BOTTOM VIEW)

Single side stable (De-energize)

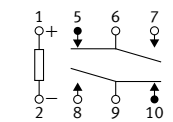

2 coil latching (Reset)

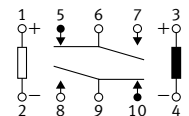

Note : Diagram shows the "reset" position when terminals 3 and 4 are energized. Energize terminals 1 and 2 to transfer contacts.

■ 4 Form C

● Plug-in terminal

CAD

External dimensions

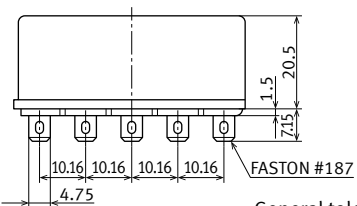
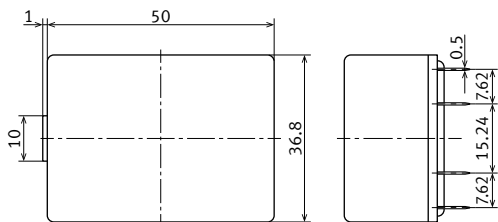

General tolerance ± 0.3

● PC board terminal

CAD

External dimensions

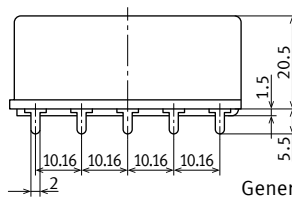
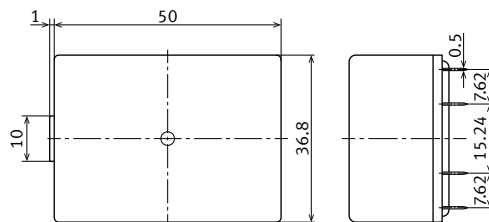

General tolerance ± 0.3

Recommended PC board pattern (BOTTOM VIEW)

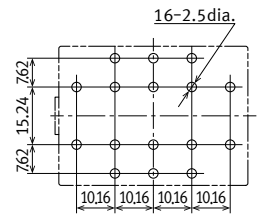

Tolerance ± 0.1

Schematic (BOTTOM VIEW)

Single side stable (De-energize)

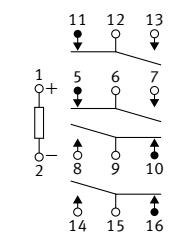

2 coil latching (Reset)

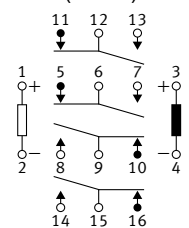

Note : Diagram shows the "reset" position when terminals 3 and 4 are energized. Energize terminals 1 and 2 to transfer contacts.

Power relays (Over 2 A) SP RELAYS

SAFETY STANDARDS

Each standard may be updated at any time, so please check our Website for the latest information.

■ UL/C-UL (Recognized)

2 Form C

File No.	Contact rating
E43028	15 A 250 V AC
	10 A 30 V DC
	1/2 HP 125, 250 V AC

4 Form C

File No.	Contact rating
E43028	10 A 250 V AC
	10 A 30 V DC
	1/3 HP 125, 250 V AC

■ TÜV (Certified)

2 Form C

File No.	Contact rating
B 11 08 13461 308	15 A 250 V AC ($\cos\phi = 1.0$)
	10 A 30 V DC

4 Form C

File No.	Contact rating
B 11 08 13461 308	10 A 250 V AC ($\cos\phi = 1.0$)
	10 A 30 V DC

■ CSA (Certified)

2 Form C

File No.	Contact rating
LR26550	15 A 250 V AC
	10 A 30 V DC
	1/2 HP 125, 250 V AC

4 Form C

File No.	Contact rating
LR26550	10 A 250 V AC
	10 A 30 V DC
	1/3 HP 125, 250 V AC

GUIDELINES FOR USAGE

- For cautions for use, please read "GUIDELINES FOR RELAY USAGE".
https://industrial.panasonic.com/ac/e/control/relay/cautions_use/index.jsp

SP RELAYS Terminal sockets



TYPES

Product name	Part No.	Standard packing	
		Inner carton	Case
SP2 Terminal socket	AR1922	10 pcs.	50 pcs.
SP4 Terminal socket	AR1942	5 pcs.	25 pcs.

RATING

Item	Specifications
Dielectric strength (initial)	Each between terminals: 3,000 V AC for 1 min (detection current: 10 mA)
Insulation resistance (initial)	Each between terminals: Min. 1,000 MΩ (at 500 V DC, Measured portion is the same as the case of dielectric strength.)
Maximum carrying current	15 A
Conditions for usage, transport and storage	Ambient temperature: -50 to +60°C Humidity: 5 to 85% RH (Avoid icing and condensation)

DIMENSIONS

CAD The CAD data of the products with a "CAD" mark can be downloaded from our Website.

Unit: mm

SP2 Terminal socket (AR1922)

CAD

External dimensions

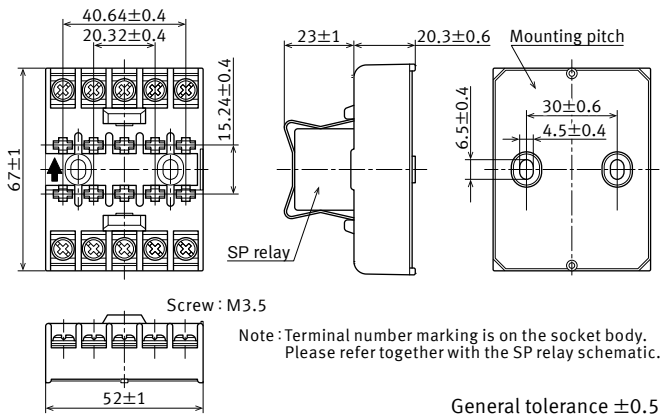

Mounting hole pattern

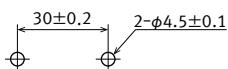

- Notes:
1. Mounting screws and the fastening bracket are included in the package.
 2. Mount the relay with the proper mounting direction — i.e. with the direction of the mark on top of the relay case matching the direction of the mark on the terminal block. (The direction of the terminal block is the upward direction of the relay.)

SP4 Terminal socket (AR1942)

CAD

External dimensions

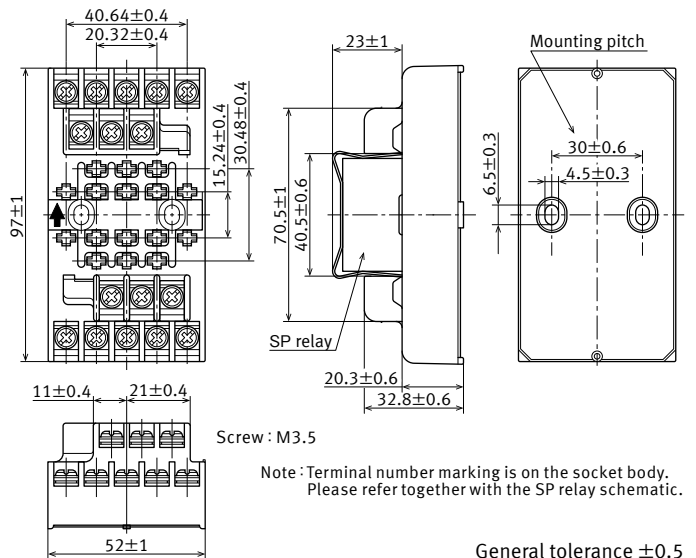

HANDLING

■ Mounting method of relay

- 1) Match the direction of relay and terminal socket.

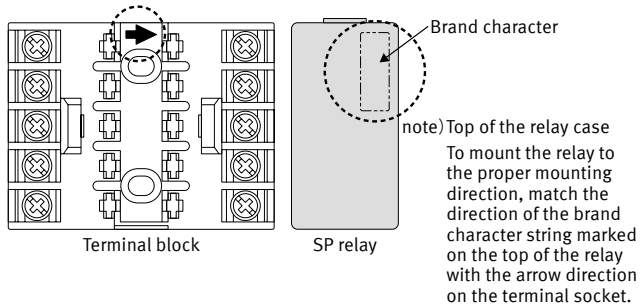

- 2) Both ends of the relay are to be secured firmly.

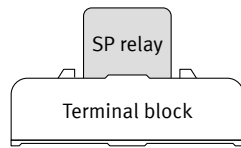

- 3) Use the included fastening bracket to firmly secure the relay.

● Mounting method of fastening bracket

- 1) Insert the A part into the mounting groove of the terminal socket.
- 2) Fit the B part into groove, while pressing with the tip of a minus screwdriver.

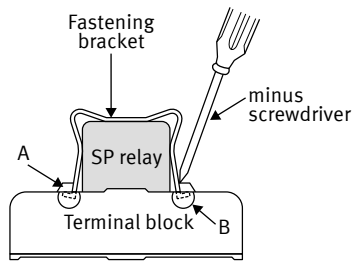

■ Removing method of relay

- 1) Pull out the relay after completely removing the fastening bracket.
- 2) Exercise care when removing relays. If greater than necessary force is applied at the socket hooks, deformation may alter the dimensions so that the hook will no longer catch, and other damage may also occur.

● Removing method of fastening bracket

- 1) Slide the B part from the groove in the terminal socket, while pressing with the tip of a minus screwdriver.
- 2) While the bracket is in this position, keep pressing the C part of the bracket to the relay side with your finger, and lift up and remove from the groove.

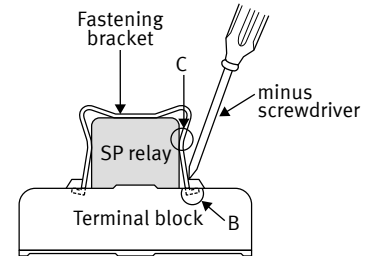

SP RELAYS Mounting board

RoHS

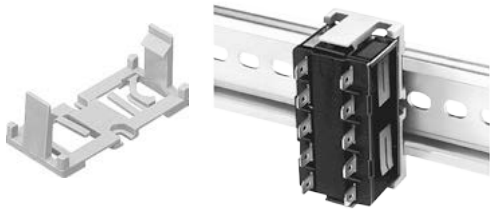

Direct chassis mounting possible, and applicable to DIN rail.

TYPES

Product name	Part No.	Standard packing	
		Inner carton	Outer carton
Mounting board	AR1800	10 pcs.	100 pcs.

RATING

Item	Specifications
Conditions for usage, transport and storage	Ambient temperature: -50 to +60°C Humidity: 5 to 85% RH (Avoid icing and condensation)
Shock resistance*	980 m/s ²
Vibration resistance	10 to 55 Hz (at double amplitude of 3 mm)

**When doing a DIN rail installation, refer to the mounting method 3) below: only direction A is 588 m/s²

DIMENSIONS

CAD The CAD data of the products with a "CAD" mark can be downloaded from our Website.

Unit: mm

CAD

External dimensions

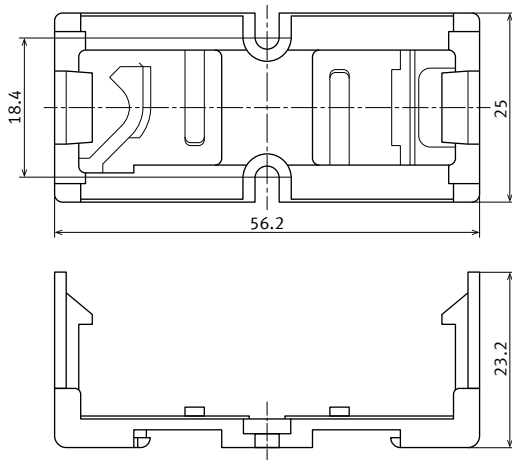

General tolerance ± 0.5

Mounting hole pattern

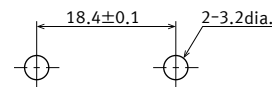

HANDLING

■ Mounting

- Both the SP relay 2 Form C and 4 Form C can be mounted to the mounting boards.
- Use the mounting boards either by attaching them directly to the chassis, or by mounting with a DIN rail.

1) When attaching directly to chassis

- Use two M3 screws.
- For the mounting pitch, refer to the dimensions.

2) When mounting on a DIN rail

- Use a 35 mm wide DIN rail (DIN46277).

■ Method for mounting on DIN rail

- 1) Fit the arc shaped claw of the mounting board into the DIN rail.

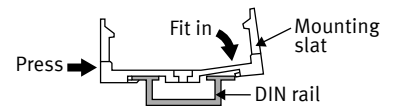

- 2) Press on the side as shown in the diagram.

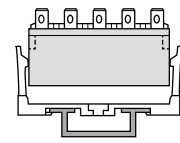

- 3) Fit in the claw part on the opposite side.

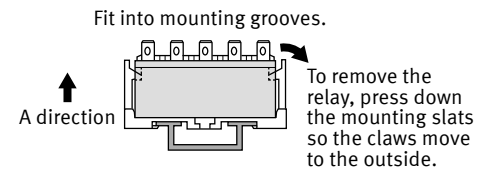

GUIDELINES FOR USAGE

- When mounting to a DIN rail, use a commercially available fastening bracket if there is a need to stop sliding of the mounting slat in the rail direction.

GUIDELINES FOR POWER, HIGH-CAPACITY DC CUT OFF AND SAFETY RELAYS USAGE

■ For cautions for use, please read “GUIDELINES FOR RELAY USAGE”.
https://industrial.panasonic.com/ac/e/control/relay/cautions_use/index.jsp

Precautions for Coil Input

■ Long term current carrying

A circuit that will be carrying a current continuously for long periods without relay switching operation. (circuits for emergency lamps, alarm devices and error inspection that, for example, revert only during malfunction and output warnings with form B contacts)
Continuous, long-term current to the coil will facilitate deterioration of coil insulation and characteristics due to heating of the coil itself. For circuits such as these, please use a magnetic-hold type latching relay. If you need to use a single stable relay, use a sealed type relay that is not easily affected by ambient conditions and make a failsafe circuit design that considers the possibility of contact failure or disconnection.

■ DC Coil operating power

Steady state DC current should be applied to the coil. The wave form should be rectangular. If it includes ripple, the ripple factor should be less than 5%.

However, please check with the actual circuit since the electrical characteristics may vary. The rated coil voltage should be applied to the coil and the set/reset pulse time of latching type relay differs for each relays, please refer to the relay's individual specifications.

■ Coil connection

When connecting coils of polarized relays, please check coil polarity (+,-) at the internal connection diagram (Schematic). If any wrong connection is made, it may cause unexpected malfunction, like abnormal heat, fire and so on, and circuit do not work. Avoid impressing voltages to the set coil and reset coil at the same time.

■ Maximum allowable voltage and temperature rise

Proper usage requires that the rated coil voltage be impressed on the coil. Note, however, that if a voltage greater than or equal to the maximum continuous voltage is impressed on the coil, the coil may burn or its layers short due to the temperature rise. Furthermore, do not exceed the usable ambient temperature range listed in the catalog.

■ Operate voltage change due to coil temperature rise

In DC relays, after continuous passage of current in the coil, if the current is turned OFF, then immediately turned ON again, due to the temperature rise in the coil, the pick-up voltage will become somewhat higher. Also, it will be the same as using it in a higher temperature atmosphere. The resistance/temperature relationship for copper wire is about 0.4% for 1°C, and with this ratio the coil resistance increases. That is, in order to operate of the relay, it is necessary that the voltage be higher than the pick-up voltage and the pick-up voltage rises in accordance with the increase in the resistance value. However, for some polarized relays, this rate of change is considerably smaller.

Ambient Environment

■ Usage, Transport, and Storage Conditions

During usage, storage, or transportation, avoid locations subjected to direct sunlight and maintain normal temperature, humidity and pressure conditions.

● Temperature/Humidity/Pressure

When transporting or storing relays while they are tube packaged, there are cases the temperature may differ from the allowable range. In this case be sure to check the individual specifications. Also allowable humidity level is influenced by temperature, please check charts shown below and use relays within mentioned conditions. (Allowable temperature values differ for each relays, please refer to the relay's individual specifications.)

1) Temperature:

The tolerance temperature range differs for each relays, please refer to the relay's individual specifications

2) Humidity: 5 to 85 % RH

3) Pressure: 86 to 106 kPa

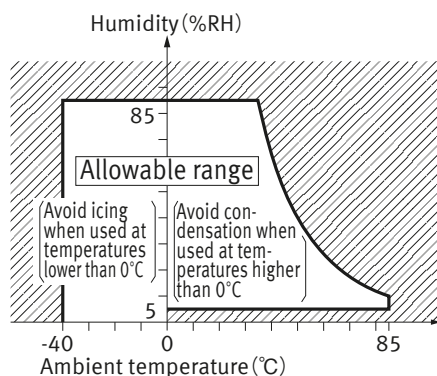

● Dew condensation

Condensation occurs when the ambient temperature drops suddenly from a high temperature and humidity, or the relay is suddenly transferred from a low ambient temperature to a high temperature and humidity. Condensation causes the failures like insulation deterioration, wire disconnection and rust etc. Panasonic Corporation does not guarantee the failures caused by condensation.

The heat conduction by the equipment may accelerate the cooling of device itself, and the condensation may occur.

Please conduct product evaluations in the worst condition of the actual usage. (Special attention should be paid when high temperature heating parts are close to the device. Also please consider the condensation may occur inside of the device.)

● Icing

Condensation or other moisture may freeze on relays when the temperature become lower than 0°C. This icing causes the sticking of movable portion, the operation delay and the contact conduction failure etc. Panasonic Corporation does not guarantee the failures caused by the icing.

The heat conduction by the equipment may accelerate the cooling of relay itself and the icing may occur. Please conduct product evaluations in the worst condition of the actual usage.

● Low temperature and low humidity

The plastic becomes brittle if the switch is exposed to a low temperature, low humidity environment for long periods of time.

● High temperature and high humidity

Storage for extended periods of time (including transportation periods) at high temperature or high humidity levels or in atmospheres with organic gases or sulfide gases may cause a sulfide film or oxide film to form on the surfaces of the contacts and/or it may interfere with the functions. Check out the atmosphere in which the units are to be stored and transported.

● Package

In terms of the packing format used, make every effort to keep the effects of moisture, organic gases and sulfide gases to the absolute minimum.

● Silicon

When a source of silicone substances (silicone rubber, silicone oil, silicone coating materials and silicone filling materials etc.) is used around the relay, the silicone gas (low molecular siloxane etc.) may be produced.

This silicone gas may penetrate into the inside of the relay. When the relay is kept and used in this condition, silicone compound may adhere to the relay contacts which may cause the contact failure.

Do not use any sources of silicone gas around the relay (Including plastic seal types).

● NOx Generation

When relay is used in an atmosphere high in humidity to switch a load which easily produces an arc, the NOx created by the arc and the water absorbed from outside the relay combine to produce nitric acid.

This corrodes the internal metal parts and adversely affects operation.

Avoid use at an ambient humidity of 85%RH or higher (at 20°C). If use at high humidity is unavoidable, please contact our sales representative.

Others

■ Cleaning

• Although the environmentally sealed type relay (plastic sealed type, etc.) can be cleaned, avoid immersing the relay into cold liquid (such as cleaning solvent) immediately after soldering. Doing so may deteriorate the sealing performance.

• Cleaning with the boiling method is recommended(The temperature of cleaning liquid should be 40°C or lower).

Avoid ultrasonic cleaning on relays. Use of ultrasonic cleaning may cause breaks in the coil or slight sticking of the contacts due to ultrasonic energy.

Please refer to **"the latest product specifications"** when designing your product.

•Requests to customers:

<https://industrial.panasonic.com/ac/e/salespolicies/>

Please contact

Panasonic Corporation

Electromechanical Control Business Division

■1006, Oaza Kadoma, Kadoma-shi, Osaka 571-8506, Japan
industrial.panasonic.com/ac/e/

Panasonic[®]

©Panasonic Corporation 2021