

S RELAYS

2 Form A 2 Form B/3 Form A 1 Form B/4 Form A /4 A Polarized power relays

Protective construction : Sealed type

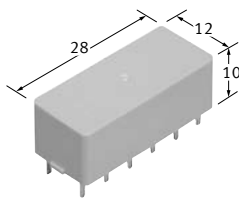

(Unit : mm)

FEATURES

- Four-pole, multi-contact arrangement (2 Form A 2 Form B, 3 Form A 1 Form B, 4 Form A)
- Low thermal electromotive force: Approx. 3μV
- Twin (bifurcated) contacts
- Latching types available
- PC board sockets are available

TYPICAL APPLICATIONS

- Measuring equipment

4-GAP BALANCED ARMATURE MECHANISM

■ Balanced armature mechanism has excellent resistance to vibration and shock

The armature structure enables free rotation around the armature center of gravity. Because the mass is maintained in balance at the fulcrum of the axis of rotation, large rotational forces do not occur even if acceleration is applied along any vector. The mechanism has proven to have excellent resistance to vibration and shock. All our S relays are based on this balanced armature mechanism, which is able to further provide many other characteristics.

■ High sensitivity and reliability provided by 4-gap balanced armature mechanism

As a (polarized) balanced armature, the S relay armature itself has two permanent magnets. Presenting four interfaces, the armature has a 4-gap structure. As a result, the rotational axis at either end of the armature is symmetrical and, in an energized into a polarized state, the twin magnetic armature interfaces are subject to repulsion on one side and attraction on the other.

This mechanism, exclusive to Panasonic Corporation, provides a highly efficient polarized magnetic circuit structure that is both highly sensitive and has a small form factor. Moreover, suitability for provision with many types of contact array and other advantages promise to make it possible to provide many of the various characteristics that are coming to be demanded of relays.

HOW IT WORKS (single side stable type)

- 1) When current is passed through the coil, the yoke becomes magnetic and polarized.
- 2) At either pole of the armature, repulsion on one side and attraction on the other side is caused by the interaction of the poles and the permanent magnets of the armature.
- 3) At this time, opening and closing operates owing to the action of the simultaneously molded balanced armature mechanism, so that when the force of the contact breaker spring closes the contact on one side, on the other side, the balanced armature opens the contact (2 Form A 2 Form B).

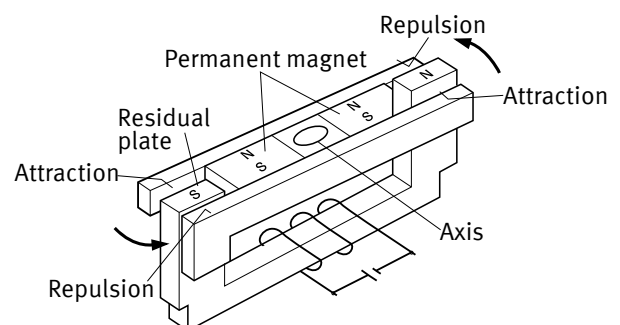

Power relays (Over 2 A) S RELAYS

ORDERING INFORMATION (PART NO. : Ordering part number for Japanese market)

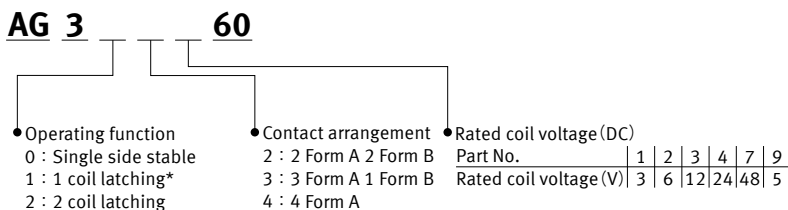

* 1 coil latching type are manufactured by lot upon receipt of order.

ORDERING INFORMATION (TYPE NO. : Ordering part number for non Japanese market)

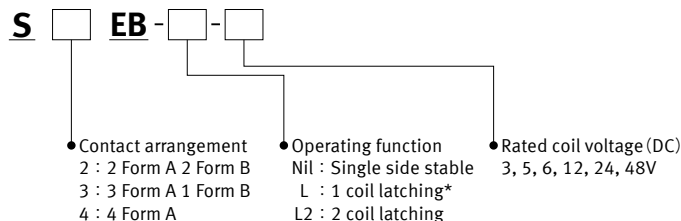

* 1 coil latching type are manufactured by lot upon receipt of order.

TYPES

" Type No. " is ordering part number for non Japanese market. " Part No. " is ordering part number for Japanese market.

Contact arrangement	Rated coil voltage	Single side stable		2 coil latching		Standard packing	
		Type No.	Part No.	Type No.	Part No.	Inner carton	Case
2 Form A 2 Form B	3 V DC	S2EB-3V	AG302160	S2EB-L2-3V	AG322160	50 pcs.	500 pcs.
	5 V DC	S2EB-5V	AG302960	S2EB-L2-5V	AG322960		
	6 V DC	S2EB-6V	AG302260	S2EB-L2-6V	AG322260		
	12 V DC	S2EB-12V	AG302360	S2EB-L2-12V	AG322360		
	24 V DC	S2EB-24V	AG302460	S2EB-L2-24V	AG322460		
	48 V DC	S2EB-48V	AG302760	S2EB-L2-48V	AG322760		
3 Form A 1 Form B	3 V DC	S3EB-3V	AG303160	S3EB-L2-3V	AG323160		
	5 V DC	S3EB-5V	AG303960	S3EB-L2-5V	AG323960		
	6 V DC	S3EB-6V	AG303260	S3EB-L2-6V	AG323260		
	12 V DC	S3EB-12V	AG303360	S3EB-L2-12V	AG323360		
	24 V DC	S3EB-24V	AG303460	S3EB-L2-24V	AG323460		
	48 V DC	S3EB-48V	AG303760	S3EB-L2-48V	AG323760		
4 Form A	3 V DC	S4EB-3V	AG304160	S4EB-L2-3V	AG324160		
	5 V DC	S4EB-5V	AG304960	S4EB-L2-5V	AG324960		
	6 V DC	S4EB-6V	AG304260	S4EB-L2-6V	AG324260		
	12 V DC	S4EB-12V	AG304360	S4EB-L2-12V	AG324360		
	24 V DC	S4EB-24V	AG304460	S4EB-L2-24V	AG324460		
	48 V DC	S4EB-48V	AG304760	S4EB-L2-48V	AG324760		

For the sockets, please refer to the "PC board sockets".

RATING

■ Coil data

- Operating characteristics such as 'Operate voltage' and 'Release voltage' are influenced by mounting conditions, ambient temperature, etc.

Therefore, please use the relay within $\pm 5\%$ of rated coil voltage.

- 'Initial' means the condition of products at the time of delivery.

● Single side stable

Rated coil voltage	Operate voltage* (at 20°C)	Release voltage* (at 20°C)	Rated operating current ($\pm 10\%$, at 20°C)	Coil resistance ($\pm 10\%$, at 20°C)	Rated operating power	Max. allowable voltage (at 40°C)
3 V DC	Max. 70% V of rated coil voltage (Initial)	Min. 10% V of rated coil voltage (Initial)	66.7 mA	45 Ω	200 mW	180% V of rated coil voltage
5 V DC			38.5 mA	130 Ω	192 mW	
6 V DC			33.3 mA	180 Ω	200 mW	
12 V DC			16.7 mA	720 Ω	200 mW	
24 V DC			8.4 mA	2,850 Ω	202 mW	
48 V DC			5.6 mA	8,500 Ω	271 mW	156% V of rated coil voltage

*square, pulse drive

● 2 coil latching

Rated coil voltage	Set voltage* (at 20°C)	Reset voltage* (at 20°C)	Rated operating current ($\pm 10\%$, at 20°C)		Coil resistance ($\pm 10\%$, at 20°C)		Rated operating power		Max. allowable voltage (at 40°C)
			Set coil	Reset coil	Set coil	Reset coil	Set coil	Reset coil	
3 V DC	Max. 70% V of rated coil voltage (Initial)	Max. 70% V of rated coil voltage (Initial)	66.7 mA	66.7 mA	45 Ω	45 Ω	200 mW	200 mW	180% V of rated coil voltage
5 V DC			38.5 mA	38.5 mA	130 Ω	130 Ω	192 mW	192 mW	
6 V DC			33.3 mA	33.3 mA	180 Ω	180 Ω	200 mW	200 mW	
12 V DC			16.7 mA	16.7 mA	720 Ω	720 Ω	200 mW	200 mW	
24 V DC			8.4 mA	8.4 mA	2,850 Ω	2,850 Ω	202 mW	202 mW	
48 V DC			7.4 mA	7.4 mA	6,500 Ω	6,500 Ω	355 mW	355 mW	135% V of rated coil voltage

*square, pulse drive

■ Specifications

Item	Specifications	
Contact data	Contact arrangement	2 Form A 2 Form B, 3 Form A 1 Form B, 4 Form A
	Contact resistance (initial)	Max. 50 m Ω (by voltage drop 6 V DC 1 A)
	Contact material	AgNi-AgSnO ₂ type, Au clad on double-layer contact
	Contact rating (resistive)	4 A 250 V AC, 3 A 30 V DC
	Max. switching power (resistive)	1,000 VA, 90 W
	Max. switching voltage	250 V AC, 48 V DC
	Max. switching current	4 A (AC), 3 A (DC) (30 to 48 V DC at less than 0.5 A)
	Min. switching load (reference value)* ¹	100 μ A 100 mV DC
Insulation resistance (initial)	10,000 M Ω (at 500 V DC, Measured portion is the same as the case of dielectric strength.)	
Dielectric strength (initial)	Between open contacts	750 V AC for 1 min (detection current:10 mA)
	Between contact sets	1,000 V AC for 1 min (detection current:10 mA)
	Between contact and coil	1,500 V AC for 1 min (detection current:10 mA)
Time characteristics (initial)	Operate (Set) time	Max. 15 ms (Max. 15 ms) at rated coil voltage (at 20°C, without bounce)
	Release (Reset) time	Max. 10 ms (Max. 15 ms) at rated coil voltage (at 20°C, without bounce, without diode)
Shock resistance	Functional	Min. 490 m/s ² (half-sine shock pulse: 11 ms, detection time: 10 μ s)
	Destructive	Min. 980 m/s ² (half-sine shock pulse: 6 ms)
Vibration resistance	Functional	10 to 55 Hz (at double amplitude of 3 mm, detection time: 10 μ s)
	Destructive	10 to 55 Hz (at double amplitude of 4 mm)
Expected life	Mechanical life	Min. 100 \times 10 ⁶ (switching frequency: 50cps)
Conditions	Conditions for usage, transport and storage* ²	Ambient temperature: -55 to +65°C, Humidity: 5 to 85% RH (Avoid icing and condensation)
Unit weight		Approx. 8 g

*1. This value can change due to the switching frequency, environmental conditions, and desired reliability level, therefore it is recommended to check this with the actual load.

*2. For ambient temperature, please read "GUIDELINES FOR RELAY USAGE".

Power relays (Over 2 A) S RELAYS

Expected electrical life

Conditions: Resistive load, switching frequency 20 times/min

Type	Switching capacity	Number of operations
2 Form A 2 Form B, 3 Form A 1 Form B, 4 Form A	3 A 30 V DC	Min. 200×10^3
	4 A 250 V AC	Min. 100×10^3

REFERENCE DATA

1. Max. switching capacity

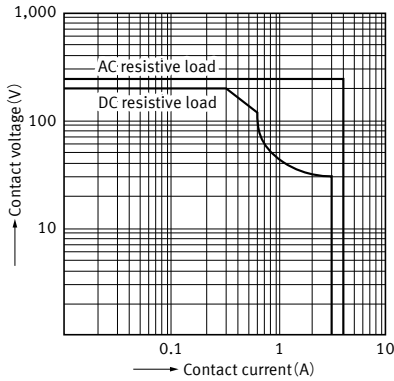

2. Switching life curve

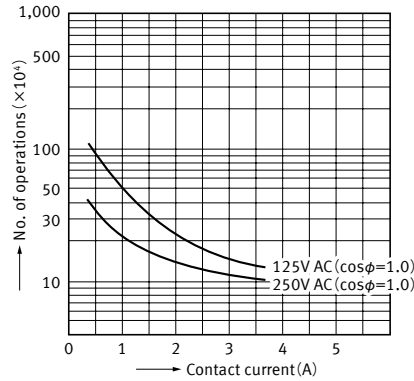

3-1. Coil temperature characteristics

Tested sample : S4EB-24V, 4 Form A

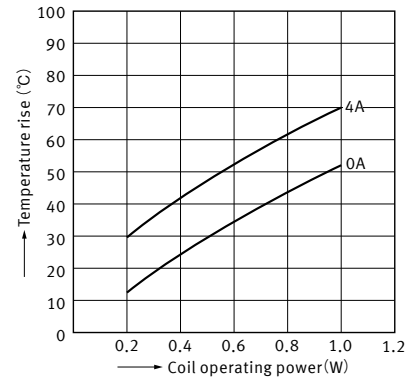

3-2. Coil temperature characteristics

Tested sample : S4EB-24V, 4 Form A

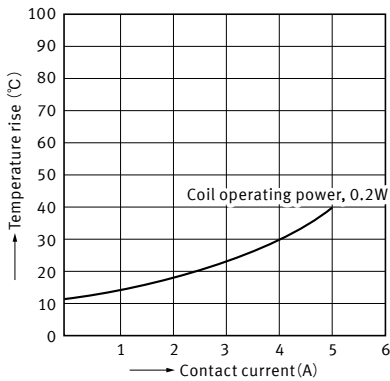

4. Contact reliability test

Tested sample : S4EB-24V, 10pcs.
Condition : 1V DC, 1mA
Detection level : 10Ω

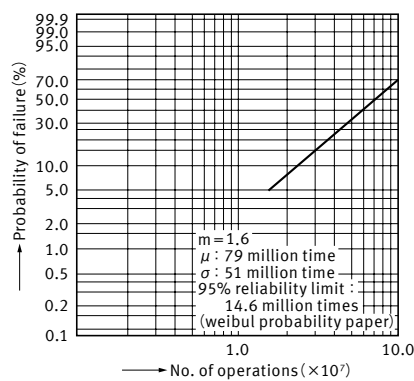

5. Operate and release time (Single side stable)

Tested sample : S4EB-24V, 10pcs.

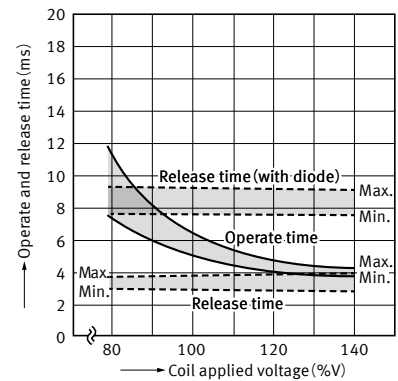

6. Influence of proximity mounting

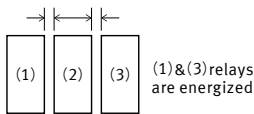

Note: When installing an S-relay near another, and there is no effect from an external magnetic field, be sure to leave at least 10mm between relays in order to achieve the performance listed in the catalog.

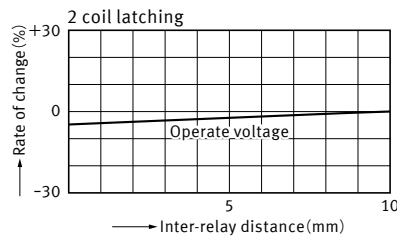
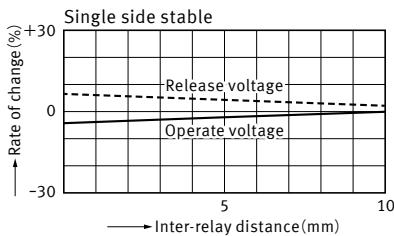

7. Influence of proximity mounting

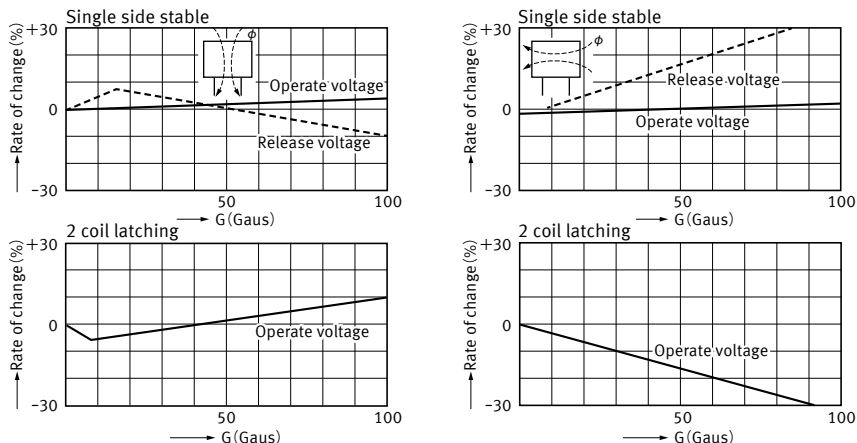

DIMENSIONS

CAD The CAD data of the products with a "CAD" mark can be downloaded from our Website.

Unit: mm

CAD

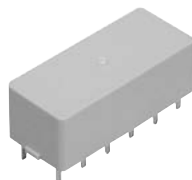

External dimensions

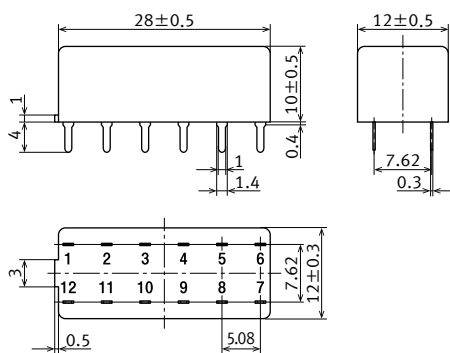

General tolerance ± 0.3

Recommended PC board pattern

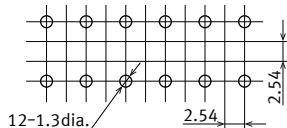

Tolerance ± 0.1

Schematic (BOTTOM VIEW)

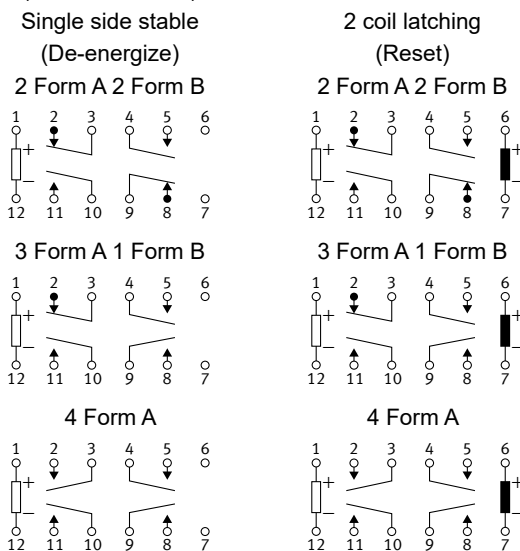

SAFETY STANDARDS

Each standard may be updated at any time, so please check our Website for the latest information.

UL (Recognized)

File No.	Contact rating
E43028	4 A 250 V AC
	3 A 30 V DC
	$\frac{1}{20}$ HP 125 V AC (FLA 1.5 A)
	$\frac{1}{20}$ HP 250 V AC (FLA 0.75 A)

CSA (Certified)

File No.	Contact rating
LR26550	4 A 250 V AC
	3 A 30 V DC
	$\frac{1}{20}$ HP 125 V AC
	$\frac{1}{20}$ HP 250 V AC

GUIDELINES FOR USAGE

■ For cautions for use, please read “GUIDELINES FOR RELAY USAGE”.
https://industrial.panasonic.com/ac/e/control/relay/cautions_use/index.jsp

■ Cautions for usage of S relays

- Based on regulations regarding insulation distance, there is a restriction on same-channel load connections between terminals No. 2, 3 and 4, 5, as well as between No. 8, 9 and 10, 11.

- Please note that when this relay (2 Form A 2 Form B type, 3 Form A 1 Form B type) operates and releases, N.O. and N.C. may go ON at the same time
- If using under conditions in which the relay will be continually powered, we recommend the latching type.

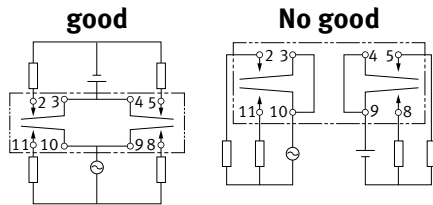

- Between 2, 3 and 4, 5: same channels, therefore possible
- Between 10, 11 and 8, 9: same channels, therefore possible

- Between 2, 3 and 4, 5: different channels, therefore not possible
- Between 10, 11 and 8, 9: different channels, therefore not possible

PC board socket

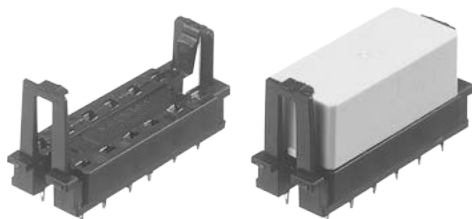

TYPES

Product name	Part No.	Standard packing	
		Inner carton	Outer carton
PC board socket	AG3801	50 pcs.	500 pcs.

RATING

Item	Specifications
Dielectric strength (initial)	Each between terminals: 1,500 V AC for 1 min (detection current: 10 mA)
Insulation resistance (initial)	Each between terminals: Min. 100 MΩ (at 500 V DC, Measured portion is the same as the case of dielectric strength.)
Maximum carrying current	4 A
Conditions for usage, transport and storage	Ambient temperature: -40 to +65°C Humidity: 5 to 85% RH (Avoid icing and condensation)

DIMENSIONS

CAD The CAD data of the products with a "CAD" mark can be downloaded from our Website.

Unit: mm

CAD

External dimensions

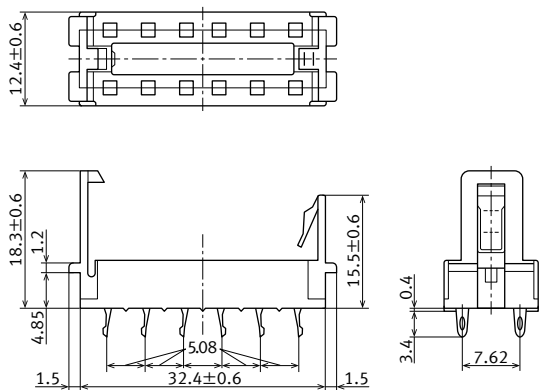

General tolerance ±0.3

Recommended PC board pattern

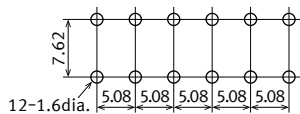

Tolerance ±0.1

HANDLING

■ Mounting method of relay

- 1) Match the direction of relay and socket.

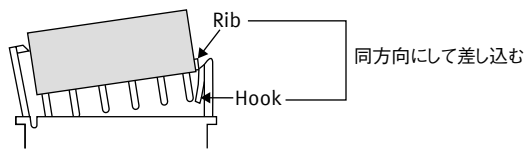

- 2) Insert both ends of the relay securely all the way until both hooks engage.

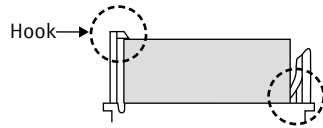

■ Removing method of relay

- 1) Remove the relay, applying force in the direction.
(Use your fingers to grab section A and remove the relay.)

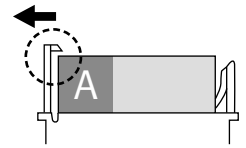

- 2) In case there is not enough space to grasp relay with fingers, use screwdrivers in the way as shown in the figure.

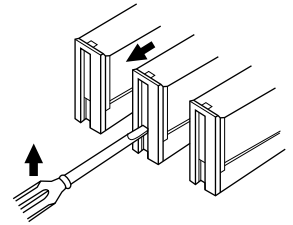

- 3) Exercise care when removing relays. If greater than necessary force is applied at the socket hooks, deformation may alter the dimensions so that the hook will no longer catch, and other damage may also occur.

GUIDELINES FOR POWER, HIGH-CAPACITY DC CUT OFF AND SAFETY RELAYS USAGE

■ For cautions for use, please read “GUIDELINES FOR RELAY USAGE”.
https://industrial.panasonic.com/ac/e/control/relay/cautions_use/index.jsp

Precautions for Coil Input

■ Long term current carrying

A circuit that will be carrying a current continuously for long periods without relay switching operation. (circuits for emergency lamps, alarm devices and error inspection that, for example, revert only during malfunction and output warnings with form B contacts)
Continuous, long-term current to the coil will facilitate deterioration of coil insulation and characteristics due to heating of the coil itself. For circuits such as these, please use a magnetic-hold type latching relay. If you need to use a single stable relay, use a sealed type relay that is not easily affected by ambient conditions and make a failsafe circuit design that considers the possibility of contact failure or disconnection.

■ DC Coil operating power

Steady state DC current should be applied to the coil. The wave form should be rectangular. If it includes ripple, the ripple factor should be less than 5%.

However, please check with the actual circuit since the electrical characteristics may vary. The rated coil voltage should be applied to the coil and the set/reset pulse time of latching type relay differs for each relays, please refer to the relay's individual specifications.

■ Coil connection

When connecting coils of polarized relays, please check coil polarity (+,-) at the internal connection diagram (Schematic). If any wrong connection is made, it may cause unexpected malfunction, like abnormal heat, fire and so on, and circuit do not work. Avoid impressing voltages to the set coil and reset coil at the same time.

■ Maximum allowable voltage and temperature rise

Proper usage requires that the rated coil voltage be impressed on the coil. Note, however, that if a voltage greater than or equal to the maximum continuous voltage is impressed on the coil, the coil may burn or its layers short due to the temperature rise. Furthermore, do not exceed the usable ambient temperature range listed in the catalog.

■ Operate voltage change due to coil temperature rise

In DC relays, after continuous passage of current in the coil, if the current is turned OFF, then immediately turned ON again, due to the temperature rise in the coil, the pick-up voltage will become somewhat higher. Also, it will be the same as using it in a higher temperature atmosphere. The resistance/temperature relationship for copper wire is about 0.4% for 1°C, and with this ratio the coil resistance increases. That is, in order to operate of the relay, it is necessary that the voltage be higher than the pick-up voltage and the pick-up voltage rises in accordance with the increase in the resistance value. However, for some polarized relays, this rate of change is considerably smaller.

Ambient Environment

■ Usage, Transport, and Storage Conditions

During usage, storage, or transportation, avoid locations subjected to direct sunlight and maintain normal temperature, humidity and pressure conditions.

● Temperature/Humidity/Pressure

When transporting or storing relays while they are tube packaged, there are cases the temperature may differ from the allowable range. In this case be sure to check the individual specifications. Also allowable humidity level is influenced by temperature, please check charts shown below and use relays within mentioned conditions. (Allowable temperature values differ for each relays, please refer to the relay's individual specifications.)

1) Temperature:

The tolerance temperature range differs for each relays, please refer to the relay's individual specifications

2) Humidity: 5 to 85 % RH

3) Pressure: 86 to 106 kPa

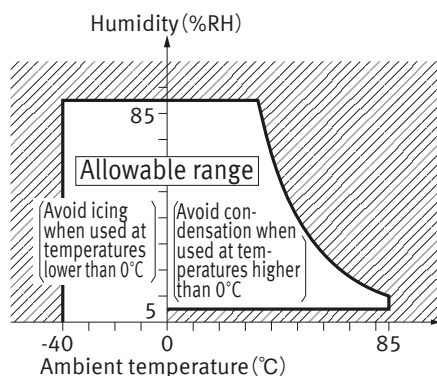

● Dew condensation

Condensation occurs when the ambient temperature drops suddenly from a high temperature and humidity, or the relay is suddenly transferred from a low ambient temperature to a high temperature and humidity. Condensation causes the failures like insulation deterioration, wire disconnection and rust etc. Panasonic Corporation does not guarantee the failures caused by condensation.

The heat conduction by the equipment may accelerate the cooling of device itself, and the condensation may occur.

Please conduct product evaluations in the worst condition of the actual usage. (Special attention should be paid when high temperature heating parts are close to the device. Also please consider the condensation may occur inside of the device.)

● Icing

Condensation or other moisture may freeze on relays when the temperature become lower than 0°C. This icing causes the sticking of movable portion, the operation delay and the contact conduction failure etc. Panasonic Corporation does not guarantee the failures caused by the icing.

The heat conduction by the equipment may accelerate the cooling of relay itself and the icing may occur. Please conduct product evaluations in the worst condition of the actual usage.

● Low temperature and low humidity

The plastic becomes brittle if the switch is exposed to a low temperature, low humidity environment for long periods of time.

● High temperature and high humidity

Storage for extended periods of time (including transportation periods) at high temperature or high humidity levels or in atmospheres with organic gases or sulfide gases may cause a sulfide film or oxide film to form on the surfaces of the contacts and/or it may interfere with the functions. Check out the atmosphere in which the units are to be stored and transported.

● Package

In terms of the packing format used, make every effort to keep the effects of moisture, organic gases and sulfide gases to the absolute minimum.

● Silicon

When a source of silicone substances (silicone rubber, silicone oil, silicone coating materials and silicone filling materials etc.) is used around the relay, the silicone gas (low molecular siloxane etc.) may be produced.

This silicone gas may penetrate into the inside of the relay. When the relay is kept and used in this condition, silicone compound may adhere to the relay contacts which may cause the contact failure.

Do not use any sources of silicone gas around the relay (Including plastic seal types).

● NOx Generation

When relay is used in an atmosphere high in humidity to switch a load which easily produces an arc, the NOx created by the arc and the water absorbed from outside the relay combine to produce nitric acid.

This corrodes the internal metal parts and adversely affects operation.

Avoid use at an ambient humidity of 85%RH or higher (at 20°C). If use at high humidity is unavoidable, please contact our sales representative.

Others

■ Cleaning

• Although the environmentally sealed type relay (plastic sealed type, etc.) can be cleaned, avoid immersing the relay into cold liquid (such as cleaning solvent) immediately after soldering. Doing so may deteriorate the sealing performance.

• Cleaning with the boiling method is recommended(The temperature of cleaning liquid should be 40°C or lower).

Avoid ultrasonic cleaning on relays. Use of ultrasonic cleaning may cause breaks in the coil or slight sticking of the contacts due to ultrasonic energy.

Please refer to **"the latest product specifications"** when designing your product.

•Requests to customers:

<https://industrial.panasonic.com/ac/e/salespolicies/>

Please contact

Panasonic Corporation

Electromechanical Control Business Division

■1006, Oaza Kadoma, Kadoma-shi, Osaka 571-8506, Japan
industrial.panasonic.com/ac/e/

Panasonic[®]

©Panasonic Corporation 2021