





产品图片	Features 产品特性	Application 应用
 <b>DIP8</b>   <b>SMD8</b>	<ul style="list-style-type: none"> <li>●Contact Form 触点形式 2a</li> <li>●Load Voltage 输出电压 40V</li> <li>●Load Current 输出电流 2A</li> <li>●Low Off-State Leakage Current 漏电流 1μA</li> </ul>	<ul style="list-style-type: none"> <li>●Automatic Test Equipment 自动检测设备</li> <li>●Telephone Equipment 通信设备</li> <li>●Sensing Equipment 传感设备</li> <li>●Security Equipment 安全设备</li> <li>●I/O Modules I/O 模块</li> <li>●Modem 调制解调器</li> </ul>

## Type 种类

Output rating 输出额定		Marking model 标 刻型号	Part No. 订货型号	
Load voltage 负载电压	Load current 负载电流		DIP 双列直插	SMD 表面贴装
40V	2A	BCW251	BCW251	BCW251A

注：表示引脚类型的“A”未标刻在产品上，订货依据订货示例型号。

## Dimensions 外形尺寸

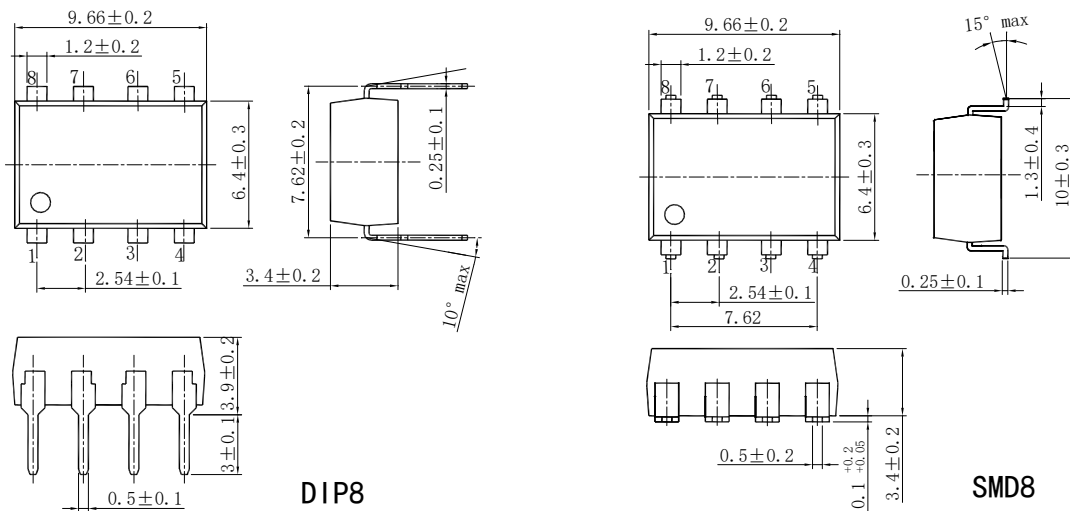

## Terminal Identification 引脚标识

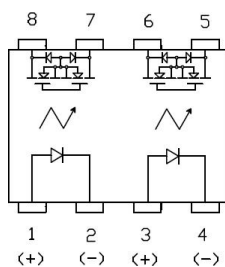

## Wiring Diagram 接线图

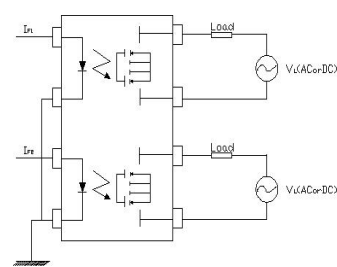

通讯地址：陕西省西安市国家民用航天产业基地航天中路385号众创广场11层1101.1102.1104室

生产地址：陕西省宝鸡市陈仓区群力路1号邮政编码：721300

电话：(0917)-6293969 18609177833

传 真：(0917)-6293969



# PhotoMOS 光 MOS 继电器 (SMD8/DIP8)

## Technical parameters 技术参数 (Ambient Temperature 25°C)

### I/O Absolute Maximum Ratings 输入输出电气参数最大值

Item 项目	Symbol 符号	BCW251		
Operating Temperature 工作温度	$T_{OPR}$	-40°C~+85°C		
Storage Temperature 储存温度	$T_{STG}$	-40°C~+100°C		
Input 输入	Continuous LED Current 工作电流	MAX. 最大值	$I_F$	50mA
	Peak LED Current LED 峰值电流 (f=100Hz, Duty=1%)	MAX. 最大值	$I_{FP}$	500mA
	LED Reverse Voltage 反向电压	MAX. 最大值	$V_R$	5V
	Input Power Dissipation 输入功耗	MAX. 最大值	$P_{IN}$	75mW
Output 输出	Load Voltage 输出电压	MAX. 最大值	$V_L$	40V (AC peak or DC)
	Load Current 输出电流	MAX. 最大值	$I_L$	2.0A
	Peak Load Current 峰值输出电流 (100ms, 1shot)	MAX. 最大值	$I_{PEAK}$	2.5A
	Output Power Dissipation 输出功耗	MAX. 最大值	$P_{OUT}$	1.8W
Total Power Dissipation 总功耗	MAX. 最大值	$P_T$	2W	
I/O Breakdown Voltage 输入输出间隔离电压	MAX. 最大值	$V_{I/O}$	3750Vrms	

### Electrical Specifications 输入输出电气参数

Item 项目	Symbol 符号	BCW251	Conditions 条件	
Input 输入	LED Forward Voltage 正向电压	TYP. 典型值	1.2V	
		MAX. 最大值	1.4V	
	Operation LED Current 接通电流	TYP. 典型值	0.5mA	
		MAX. 最大值	3mA	
Recovery LED Voltage 关断电压	MIN. 最小值	$V_{F OFF}$	0.7V	
Output 输出	On-Resistance 导通电阻	TYP. 典型值	$R_{ON}$	0.06Ω
		MAX. 最大值		0.1Ω
	Off-State Leakage Current 漏电流	MAX. 最大值	$I_{LEAK}$	1μA
Output Capacitance 输出端容量	TYP. 典型值	$C_{OUT}$	190pF	$V_L=0V, f=1MHz$
Timeparameters 时间参数	Turn-On Time 接通时间	TYP. 典型值	$T_{ON}$	0.8ms
		MAX. 最大值		1.5ms
	Turn-Off Time 关断时间	TYP. 典型值	$T_{OFF}$	0.02ms
		MAX. 最大值		0.5ms
I/O 输入输出	I/O Insulation Resistance 绝缘电阻	MIN. 最小值	$R_{I/O}$	1000MΩ
	I/O Capacitance 隔离电容	TYP. 典型值	$C_{I/O}$	0.8pF
		MAX. 最大值		1.5pF

通讯地址: 陕西省西安市国家民用航天产业基地航天中路385号众创广场11层1101.1102.1104室

生产地址: 陕西省宝鸡市陈仓区群力路1号 邮政编码: 721300

电话: (0917)-6293969 18609177833

传 真: (0917)-6293969



# PhotoMOS 光 MOS 继电器 (SMD8/DIP8)

## Reference Data 参考数值 (BCW251)

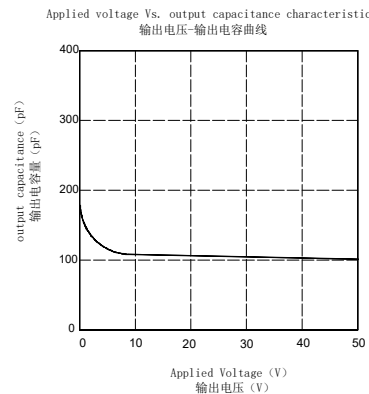
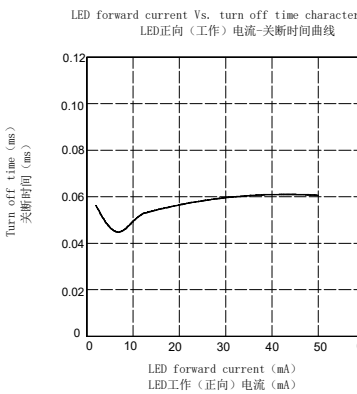
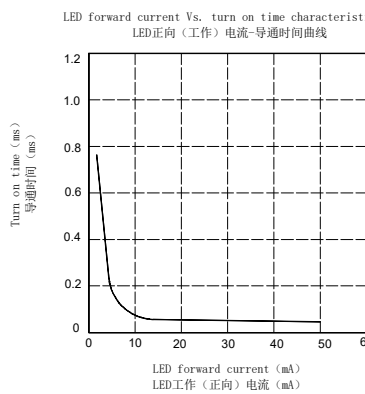
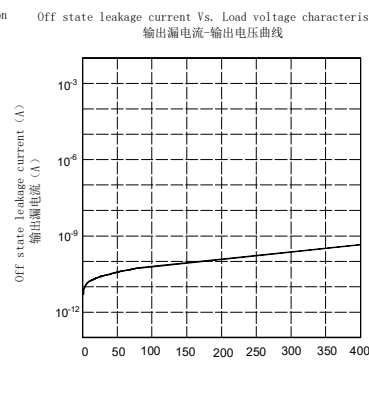
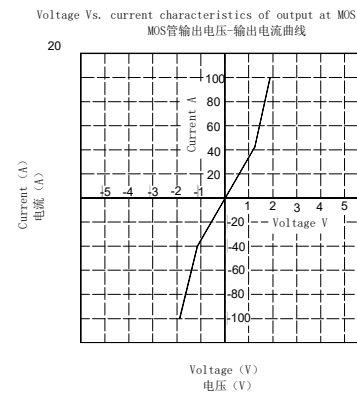
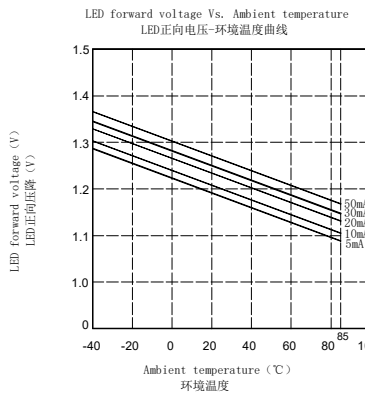
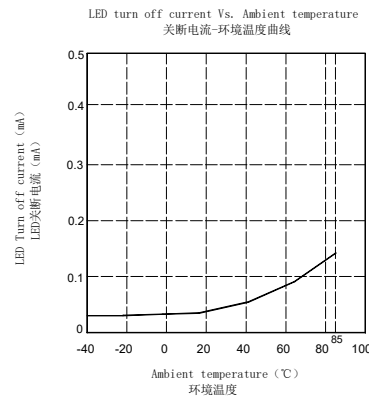
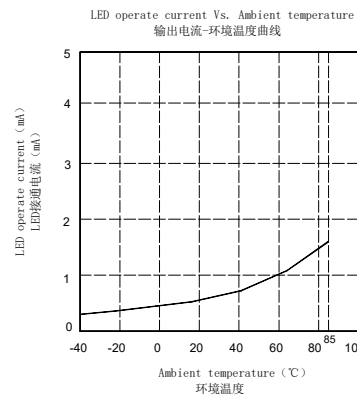
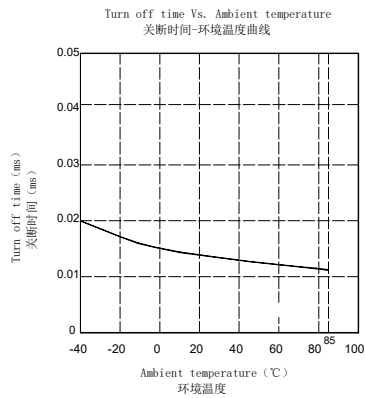
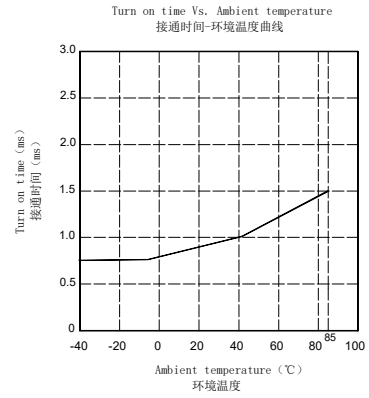
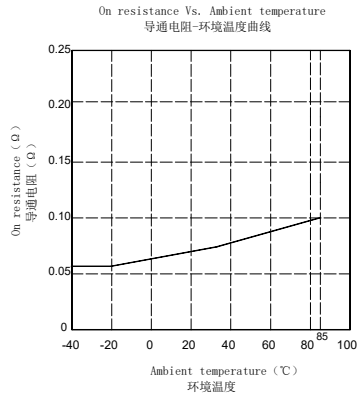
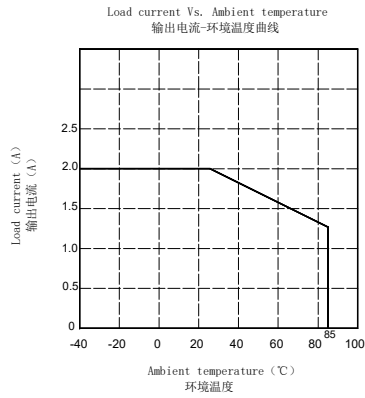

通讯地址: 陕西省西安市国家民用航天产业基地航天中路385号众创广场11层1101.1102.1104室

生产地址: 陕西省宝鸡市陈仓区群力路1号 邮政编码: 721300

电话: (0917)-6293969 18609177833

传 真: (0917)-6293969