



# 盛元继电器 CHENGYUAN RELAY

## CY115F

## 小型功率继电器

## Miniature Power Relay

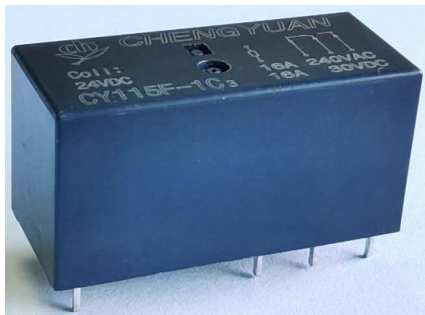

### 特点Features

- 高负载能力：16安触点切换  
High load capacity : 16A switching capability
- 体积小，适用于密集安装  
Small in size and suitable for intensive installation
- 耐压可达5000伏  
Pressure resistance is up to 5000volts

### 触点参数 Contact Data

型号 Type	CY115F
触点材料 Contact material	银合金 Silver alloy
接触电阻 Contact resistance	100mΩ Max.(at 1A 6VDC)
额定负载 (阻性) Rated load (Resistive load)	16A 250VAC
最大切换电流 Max. switching current	16A
最大切换电压 Max. switching voltage	277VAC
最大切换功率 Max. switching power	4432VA
最小切换负载 Min. switching load	6V 1A

### 性能参数 Characteristics

吸合时间 (额定电压) Operate time (at rated coil voltage)	15ms Max. (不加二极管 No diode)	
释放时间 Release time	5ms Max. (不加二极管 No diode)	
绝缘电阻 Insulation resistance	Min. 1000MΩ (at 500VDC)	
介质耐压 Dielectric strength	触点与触点间	Between open contacts:1000VAC, 50/60Hz for 1min
	触点与线圈间	Between coil and contact : 5000VAC , 50/60Hz for 1min
抗振动 Vibration resistance	耐久Destructive	10-55Hz,双振幅1.5mm 10-55Hz ,at double amplitude of 1.5 mm
	误动作Functional	10-55Hz,双振幅1.5mm 10-55Hz ,at double amplitude of 1.5 mm
抗冲击 Shock resistance	误动作Functional	10G Min.
	耐久Destructive	100G Min.
寿命 Endurance	机械寿命 (每小时10800次, 室温) Mechanical endurance (10800ops./h)	10000000次 10000000 ops.(at room temperature)
	电气寿命 (每小时360次, 室温) Electrical endurance (360ops./h)	100000次 100000 ops.(at room temperature)
环境温度Ambient atemperature	-40°C ~ +85°C(不冷凝 no condensation)	
重量Weight	约13.5g Approx.13.5g	

宁波市鄞州盛元电子器件厂版权所有， 本厂保留所有权利。

NingBo YinZhou ChengYuan Electronic Device Factory, All rights reserved.

Version:V2010.20

## 线圈参数 Coil Data (at 20°C)

额定电压 (VDC) Nominal voltage (VDC)	额定电流 ±10%(mA) Nominal operating current ±10%(mA)	线圈电阻 ±10%(Ω) Coil resistance ±10%(Ω)	额定功率 Nominal operating power	吸合电压(Max.) Operate voltage (Max.)	释放电压 (Min.) Release voltage (Min.)	最大连续外加电压 Max. allowable voltage
5	80.00	62.5	约0.4W Approx 0.4W	额定电压的75% 75% of nominal voltage	额定电压的5% 5% of nominal voltage	额定电压的130% 130% of nominal voltage
6	66.67	90				
9	44.44	202.5				
12	33.33	360				
18	22.22	810				
24	16.67	1440				
48	8.33	5760				

上述值为初始值，请勿在产品上连续施加最大电压>10min，以免线圈过度发热。

The data shown above are initial values. Do not apply maximum allowable voltage on coil for more than 10 minutes to avoid overheating of the coil.

## 外形尺寸图、接线图、安装孔位图 (单位: mm) Outline dimension, Wiring diagram, PCB layout (Unit:mm)

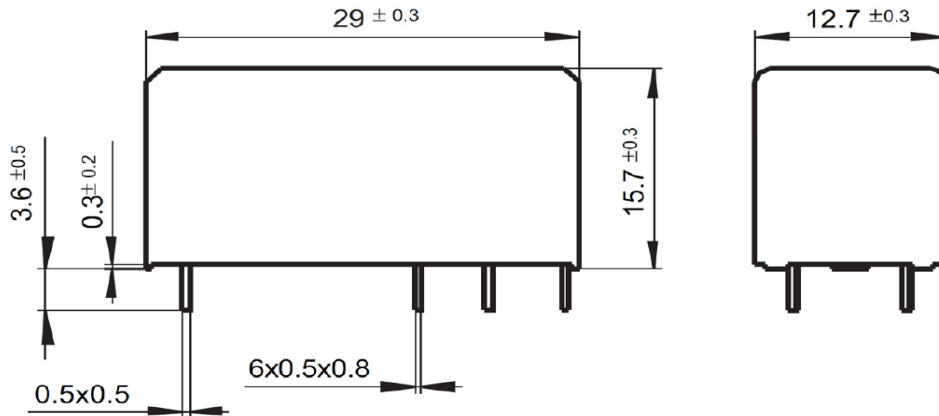

3A



3B

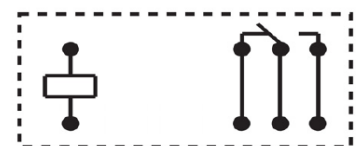

3C

接线图 (底视图)

Wiring Diagram (bottom view)

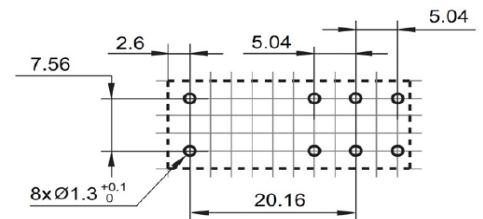
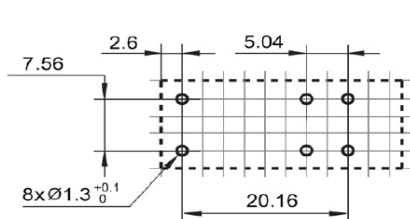
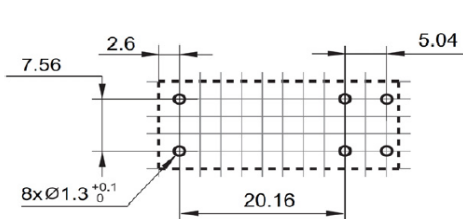

安装孔位图 (底视图)

P.C.B. Layout (bottom view)

## 性能曲线图 Characteristic Curves

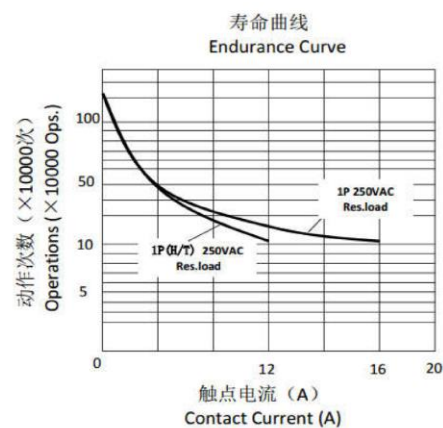
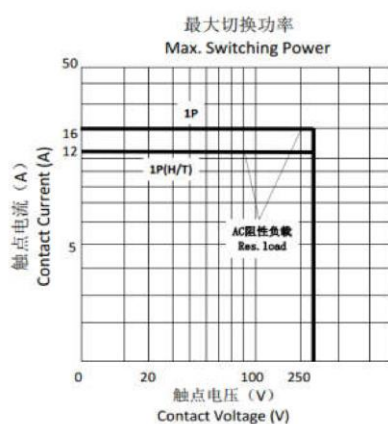
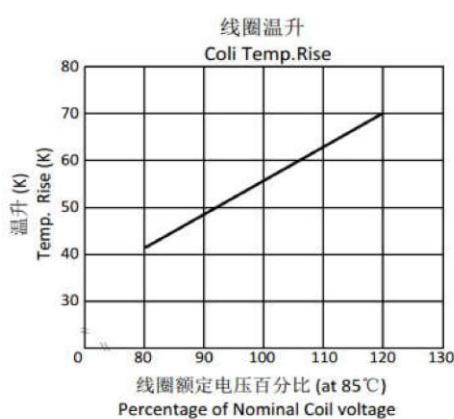

## 典型用途 Typical Applications

家用电器、洗衣机、空调、微波炉、音响、显示器、工业控制仪等

Home appliances, washing machine, air-conditioning, microwave oven, sound, monitor, industrial control instrument, etc.

## 订货标记 Ordering Information

CY115F - 1 - C - 12VDC - B - D - T - XX  
1 2 3 4 5 6 7 8

- 1: 型号Type: CY115F
- 2: 触点组数Number of Poles: 1-1Pole
- 3: 触点形式Contact Arrangement: A-Form A ; B-Form B ; C-Form C
- 4: 额定电压Nominal Voltage: 5,6,9,12,18,24,48VDC
- 5: 外壳颜色Enclosure Color: B-黑色Black
- 6: 线圈功耗Coil Pwor: D-0.4W
- 7: 封装形式Protective Construction: S-塑封式Flux proofed,  
SH-防水式 Sealed type washable
- 8: 特殊参数Special Parameter:无-标准型 Nil-Standard type  
字母或数字-特殊要求Letter or number-Special requirement

(1): 塑封式不能在污染环境 (含有H<sub>2</sub>S, SO<sub>2</sub>, NO<sub>2</sub>, 粉尘等污染特) 中使用。

Flux-proof relays can not be used in the environment with pollutants like H<sub>2</sub>S, SO<sub>2</sub>, NO<sub>2</sub>, dust, etc.

(2): 塑封式装入PCB焊接后, 不能进行整体清洗或表面处理。

Water cleaning or surface process is not suggested after the flux-proof relays are assembled on PCB.

(3): 客户特殊要求 (XX), 由我司评估后, 按特性符号标识。

声明: 本产品规格书仅供客户使用时参考, 若有更改, 恕不另行通知。

对盛元而言, 不可能评定继电器在每个具体应用领域的所有性能参数要求, 因而客户应该根据具体的使用条件选择与之相匹配的产品。对于密封继电器在安装清洗后, 使用前请打开外壳上的透气孔。如有疑问, 请与盛元联系获得更多的技术支持。但产品选型责任仅由客户负责。

Disclaimer: The specification is for reference only. Specifications are subject to change without prior notice.

We could not evaluate all the performance and all the parameters for every possible applications. Thus the users should in a right position to choose suitable product for their own application. For sealed relays, after installation and cleaning, please open the ventilation hole in the case before use. If there is any query, please contact Chengyuan for technical services. However it is the user's responsibility to determine which product should be used.