

HHC68B(HH52,53,54P) 小型电磁继电器

型号说明

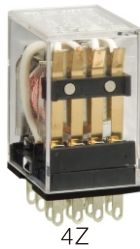

HHC68B(HH52P)-L-2Z-12VDC

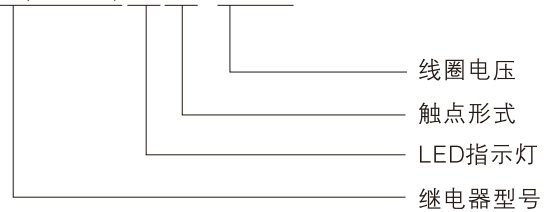

产品特点

◇超小型体积；◇功耗低；◇触点负载大；◇高灵敏度；◇可配置指示灯；

技术参数

	形式	2Z,2H,2D	3Z,3H,3D	4Z,4H,4D
	触点	负载(阻性)	5A/240VAC 28VDC	
接触电阻(初始)		≤100mΩ		
材料		银合金		
电气寿命(频率1S通,1S断)		≥10 ⁵ 次		
机械寿命(频率300次/1分钟)		≥10 ⁷ 次		
吸合电压(23°C)		DC: ≤75% × 额定电压, AC: ≤80% × 额定电压		
释放电压(23°C)		DC: ≥10% × 额定电压, AC: ≥30% × 额定电压		
最大电压(23°C)		110% × 额定电压		
线圈规格	直流(DC)	6V,9V,12V,24V,36V,48V,110V,220V(电压可订制)		
	交流(AC)	6V,9V,12V,24V,36V,48V,110V,220V,380V(电压可订制)		
线圈功率	直流(DC)	0.9W		
	交流(AC)	1.2VA		
吸合时间		≤15ms		
释放时间		≤10ms		
初始耐压	同极触点之间	1000VAC/1min(漏电流 1mA)		
	异极触点之间	1000VAC/1min(漏电流 1mA)		
	触点与线圈间	1500VAC/1min(漏电流 1mA)		
绝缘电阻		≥100MΩ(500VDC)		
环境温度		-25~+55°C		
环境湿度		45%~75%RH		
大气压力		86~106KPa		
耐冲压		10G(正弦半波脉冲:11ms)		
耐振动		10~55Hz 双振幅: 1.0mm		
安装方式		PCB印刷板焊接式, 导轨插座式, 螺栓安装式		
包装信息	内盒数量	20只/纸盒, 50只/泡沫盒		
	外箱数量	纸盒:600/箱, 泡沫盒:500只/箱		
	外箱尺寸	600只装: 330mm×310mm×345mm; 500只装: 440mm×310mm×345mm		
	重量	大约35g/只,600只装: 毛重22KG/箱,净重21KG/箱; 500只装: 毛重19KG/箱,净重18KG/箱		

外形图、接线图、安装尺寸(mm)

HHC68B-2Z(HH52P)

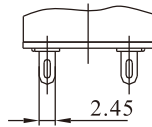
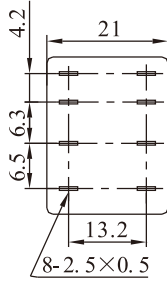
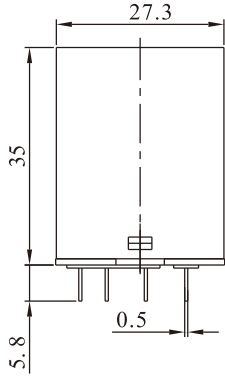

插座式引出端

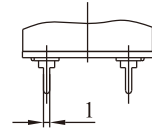

线路板焊接式引出端

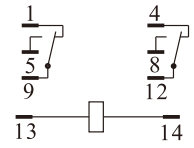

HHC68B-3Z(HH53P)

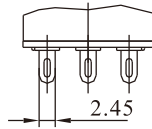
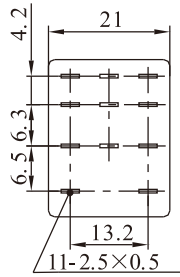
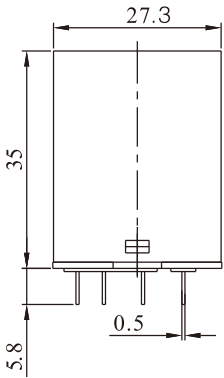

插座式引出端

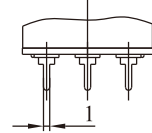

线路板焊接式引出端

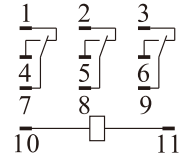

HHC68B-4Z(HH54P)

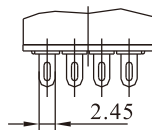
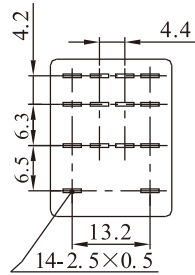
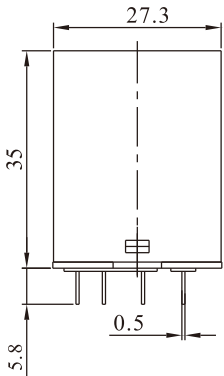

插座式引出端

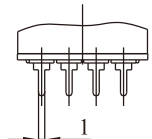

线路板焊接式引出端

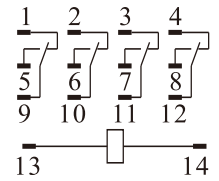

HHC68B(HH52,53,54P)法兰式螺丝安装尺寸

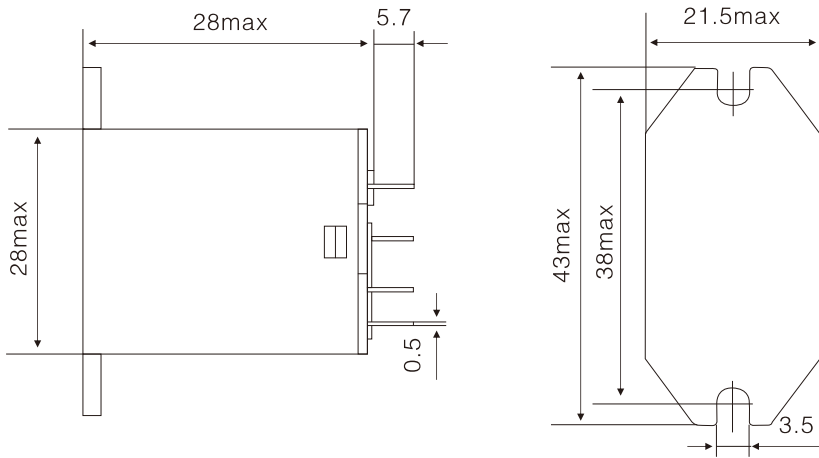

性能曲线图

