

DS908L

特性/Key Characteristics:

- 90A触点分断能力
- 双路继电器
- 符合RoHS
- 符合IEC62055-31 Uc2
- Switching current:90A
- Two pole/phase relay
- RoHS
- IEC62055-31 Uc2



基本参数/Basic Data

线圈脉冲宽度Coil pulse width	50ms Min.	
动作时间Operation time	20ms Max.	
复归时间Comeback time	20ms Max.	
介质耐压Dielectric strength (50/60Hz) for 1 min	触点与线圈Between coil&contact	4000VAC/min
	断开触点间Between contacts	1800VAC/min
绝缘电阻Insulation resistance	Min.1000MΩ(500VDC)	
环境温度Ambient Temp.	-40℃~+85℃	
重量Weight	85g	
引出端方式Terminal type	PCB&QC	
封装形式Package	塑料、防尘 Plastic sealed dusted proof	
外形尺寸Size(mm)	42*32*35	

触点参数/Contact Data

触点形式Contact form	2A 2B
触点材料Contact material	AgSnO ₂
接触电阻Contact resistance	0.8mΩ Max.(12VDC 1A)
额定负载Contact current(Cos Φ =1)	90A 250VAC
最大断开电压Max disconnection voltage	440VAC/110VDC
最大断开功率Max disconnection power	22,500VA
额定负载电气寿命(阻性/感性)Electrical life	5,000 cycles(load) resistive / 5,000 cycles sensual
机械寿命Mechanical life	100,000 cycles

线圈参数/Coil Data

额定电压(VDC) Rated Voltage	电阻 Resistance $\pm 10\%$ (Ω)		吸合/释放电压(VDC) Rated Voltage
	单线圈Single	双线圈Dual	
6	8	4×2	$\leq 70\%$ 额定电压 Rated voltage
9	18	9×2	
12	32	16×2	
24	128	64×2	

安装尺寸Installation Size(mm)

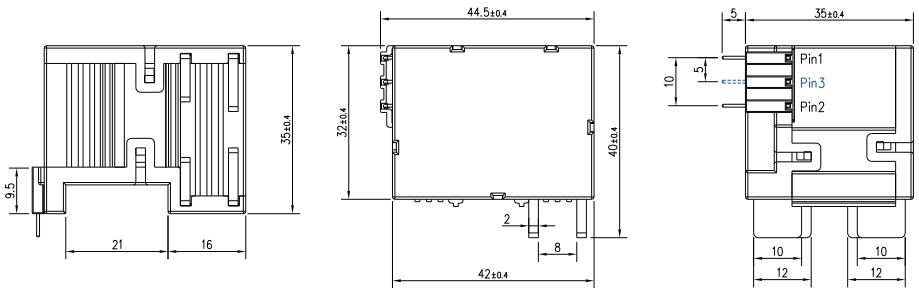

接线图Connection Diagram

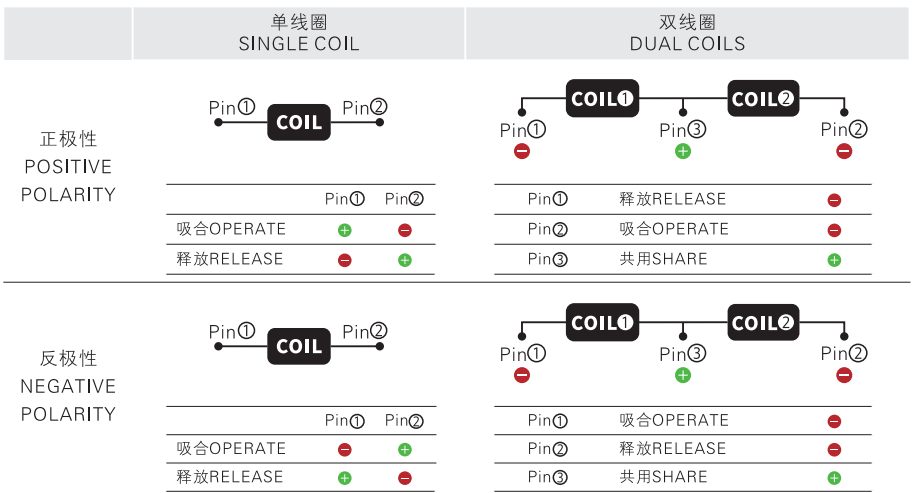

典型外形图Typical type

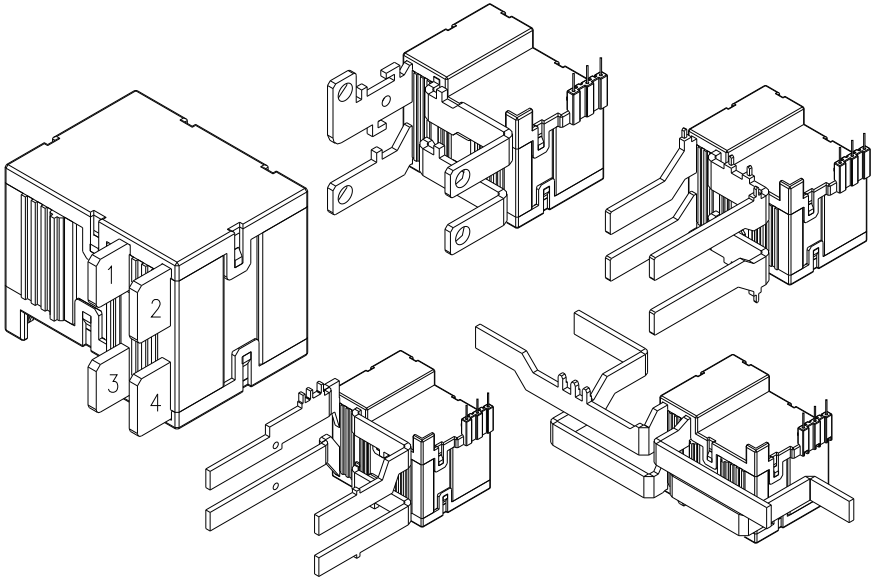

注意事项Application Notes

1. 所有继电器在出厂时都设为闭合状态。在装运或组装的过程中继电器可能会变成释放的状态。因而使用时（电源接入时）请根据需要重新将其设置为复归状态。
 2. 为了使继电器保持在吸和或释放的状态，线圈电压需达到额定电压，为确保磁保持继电器动作或复归脉冲宽度不小于50ms。不要向线圈上的Pin1和Pin2施加电压超过一分钟以上，以防线圈损坏。
 3. 继电器有极性区分，用户需指明属于何种极性。
 4. 继电器入厂检验及使用轻拿轻放，防止损坏影响参数，入厂作破坏性检查的产品要与正常产品严格区分标识，不得装机使用。
 5. 非带铜绞线的继电器，负载引脚不能焊锡，引脚针刚性固定，不能随意扭动。
1. All the relays are shipped in the "operate" position because it is possible that during transit or final assembly the relay could change its state to the "release" position. Please reset the relay into "operate" state when put in circuit according to need.
 2. In order to maintain "operate" or "release" state of the relay, the coil voltage should reach the rated voltage. The pulse width should be 60ms or longer to ensure a proper change of state. Do not energize both Pin1 and Pin2 at the same time on the coil for longer than 1 min (damage to the coil).
 3. Relays are classified according to the polarity, if client need different form from information, please contact us.
 4. The relay into the factory for destructive inspection should be protected from damage and strict distinction between the normal products.
 5. Not with braided line relay, the load pin can not solder, not arbitrarily wrenched, two pins and rigid fixation.