

FEATURES特点

- UL ,CE & CQC safety approval.
UL ,CE 及 CQC 安全认证
- 2 Pole to 4 Pole are prepared with switching current of 7A (2 pole, 3 pole) and 5A (4 pole).
2组到4组转换接点形式，切换电流7A(2组、3组)及5A(4组)
- PCB terminal and Socket terminal are selectable, and flange case type is available.
有电路板端子及插座式端子可供选择,以及法兰式外盖可供选用
- Nominal power 900mW & AC 1.2VA.
正常功耗:直流为 900mW 及交流为 1.2VA
- Operating power DC510mW.
动作功耗直流 510mW
- Optional to be equipped with lamp, diode
另有带灯和二极管可供选配



UL FILE NO.: E162117
CQC FILE NO.: CQC04001009878
CE DECLARATION OF CONFORMITY
用途: 自动控制、通讯设备、
家用电器及机床电器

CONTACT RATING 接点参数

Contact form接点形式	2C DPDT	3C 3PDT	4C 4PDT
Max. Switching Power最大切换功率	1750VA 210W		1250VA 150W
Max. Switching Voltage最大切换电压	250VAC 30VDC		
Max. Switching Current最大切换电流	7A		5A
Min. Switching Current / Voltage 最小切换电流/电压	100mA 5VDC		
Rating Load(Resistive)额定负载(阻性)	7A 250VAC 7A 30VDC		5A 250VAC 5A 30VDC
Contact Material接点材质	Ag Alloy银合金		

CHARACTERISTICS 性能参数

Electrical Life 电气寿命	1 × 10 ⁵	
Mechanical Life机械寿命	1 × 10 ⁷	
Insulation Resistance绝缘阻抗	Min. 100MΩ 500VDC	
Contact Resistance(Initial)接触电阻	≤ 100mΩ (6VDC 1A)	
Operate Time 动作时间	≤ 25ms	
Release Time 开放时间	≤ 25ms	
Initial Dielectric Strength 耐压	between open contacts开放接点间: 50/60Hz 500VAC 1min. between contacts and coil线圈接点间: 50/60Hz 1500VAC 1min. between contact sets接点组间: 50/60Hz 1500VAC 1min.	
Vibration Resistance 耐振动	Malfuction: 误动作:	10 ~ 55Hz Double Amplitude双振幅 1.5mm
	Damage limits: 耐久:	10 ~ 55Hz Double Amplitude双振幅 1.5mm
Shock Resistance 耐冲击	Malfuction: 误动作:	10G
	Damage limits: 耐久:	100G
Ambient Temperature环境温度	-25℃ ~ +55℃ (No freezing 无结冰)	
Relative Humidity相对湿度	85% at 40℃	
Unit Weight单位重量	Approx. 35g	

ORDERING INFORMATION 型号代码说明

952 - 4C - 12 D P M L G - F
 1 2 3 4 5 6 7 8 9

<ol style="list-style-type: none"> 1. Model Number 型号 2. Contact Arrangement 接点形式 2C = 2 Form C (DPDT) 2组转换 3C = 3 Form C (3PDT) 3组转换 4C = 4 Form C (4PDT) 4组转换 3. Coil Voltage 线圈电压 6、12、24、48、100VDC 12、24、110、120、220、240VAC 4. Coil Type 线圈形式 D=DC直流 A=AC交流 5. Terminal Type 端子形式 Nil = Socket Terminal 插座型端子 P = P.C.B. Terminal 电路板型端子 	<ol style="list-style-type: none"> 6. Cover Type 外盖形式 Nil = General Type 普通型 M = Flange Type 法兰式 7. Optional 选择 Nil = General Type 普通型 L = With Lamp and Diode (DC Coil Type only) 带灯及二极管(仅限直流线圈) N = With Lamp 带灯 8. Contact Type 接点形式 Nil = General Type 普通型 G = Contact with Gold Plating 接点镀金型 9. Type of Insulation 绝缘形式 Nil = Class A F = Class F
---	---

COIL RATINGS (at 20°C) 线圈额定值 (在20°C)

COIL TYPE 线圈形式	Coil Nominal Voltage 线圈额定电压 (V)	Coil Resistance 线圈阻抗 ($\Omega \pm 10\%$)	Pick-Up Voltage 动作电压(V) (Max)	Drop-Out Voltage 开放电压(V) (Min)	Nominal Current 额定电流 (mA)
DC Coils 直流线圈 (abt. 0.9W)	6	40	4.5	0.6	150
	12	160	9	1.2	75
	24	650	18	2.4	37
	48	2600	36	4.8	19
	100	11000	75	10	9
AC Coils 交流线圈 (abt. 1.2VA)	12	46	9.6	3.6	
	24	180	19.2	7.2	
	110	3750	88	33	
	120	4430	96	36	
	220	12950	176	66	
	240	18790	192	72	

* Max Continuous Voltage at 20°C: 110% of Coil Normal Voltage.

最大使用电压在20°C:线圈额定电压的110%

OUTLINE DIMENSIONS 外部尺寸

UNIT: mm(inch) 单位: 毫米(英寸)

GENERAL TYPE 普通型

Socket Terminal 插座式端子

Dimensions尺寸

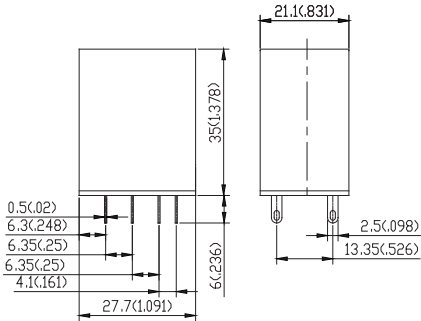

Internal Connections 接线图
(Bottom View底视图)

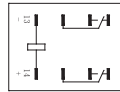

2 Form C

Drilling Plan 孔位图
(Bottom View底视图)

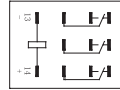
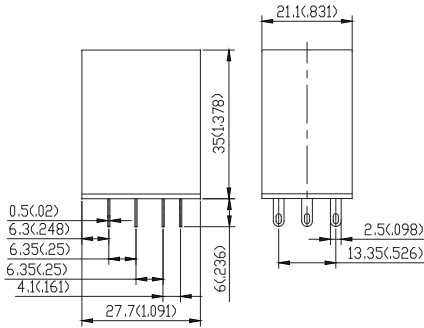
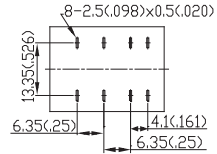

3 Form C

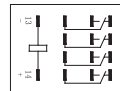
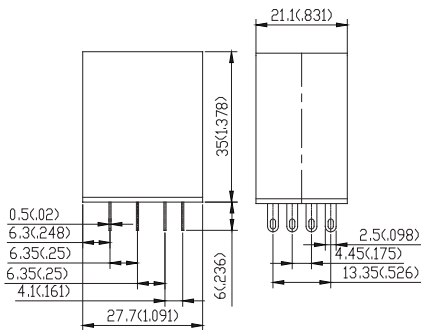
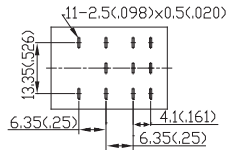

4 Form C

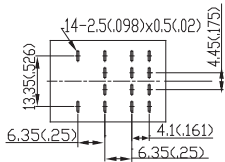

*REMARK: Dimensions $\leq 5\text{mm} \pm 0.2\text{mm}$, $> 5\text{mm} \pm 0.3\text{mm}$, the tolerance of PCB thru hole: $+0.2\text{mm}$

备注: 尺寸公差 $\leq 5\text{mm} \pm 0.2\text{mm}$, $> 5\text{mm} \pm 0.3\text{mm}$, 印刷电路板孔 $+0.2\text{mm}$

*The polarity of coil is only applied for DL, DN, DPL and DPN type 线圈极性仅适用于DL, DN, DPL 及 DPN

OUTLINE DIMENSIONS 外部尺寸

UNIT: mm(inch) 单位: 毫米(英寸)

P.C.B Terminal 电路板式端子

Dimensions 尺寸

Internal Connections 接线图
(Bottom View 底视图)

Drilling Plan 孔位图
(Bottom View 底视图)

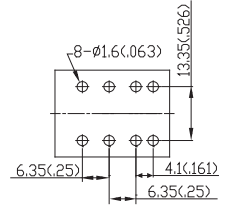
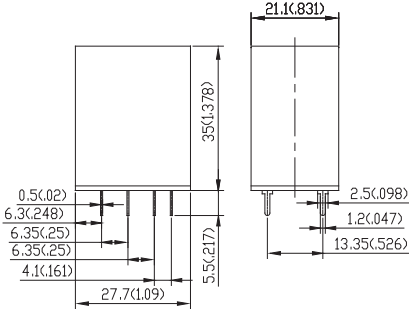

2 Form C

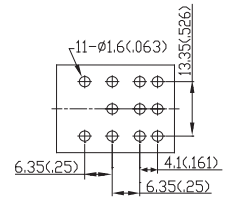
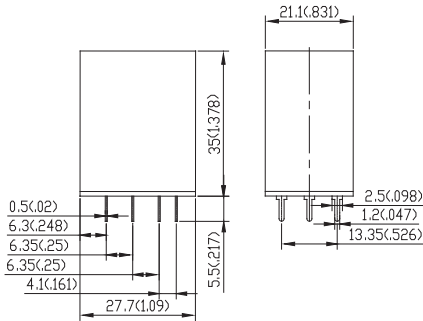

3 Form C

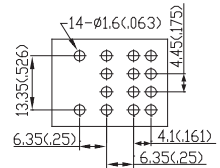
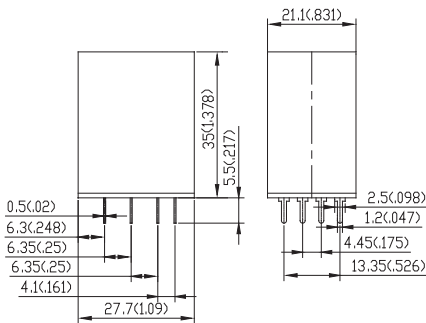

4 Form C

*REMARK: Dimensions $\leq 5\text{mm} \pm 0.2\text{mm}$, $> 5\text{mm} \pm 0.3\text{mm}$, the tolerance of PCB thru hole: $+0.2\text{mm}$

备注: 尺寸公差 $\leq 5\text{mm} \pm 0.2\text{mm}$, $> 5\text{mm} \pm 0.3\text{mm}$, 印刷电路板孔 $+0.2\text{mm}$

*The polarity of coil is only applied for DL, DN, DPL and DPN type 线圈极性仅适用于DL, DN, DPL 及 DPN

OUTLINE DIMENSIONS 外部尺寸

UNIT: mm(inch) 单位: 毫米(英寸)

Flange Top Type 法兰式
Socket Terminal 插座式端子

Dimensions尺寸

Internal Connections接线图
(Bottom View底视图)

Drilling Plan孔位图
(Bottom View底视图)

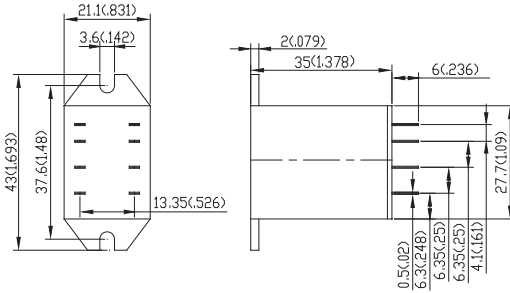

2 Form C

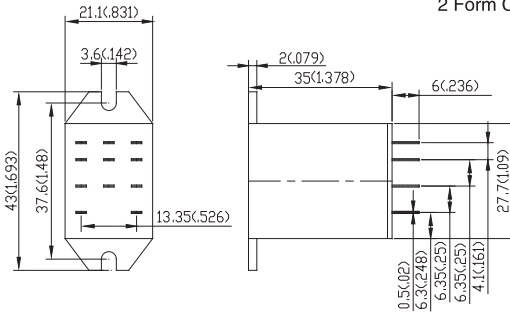

3 Form C

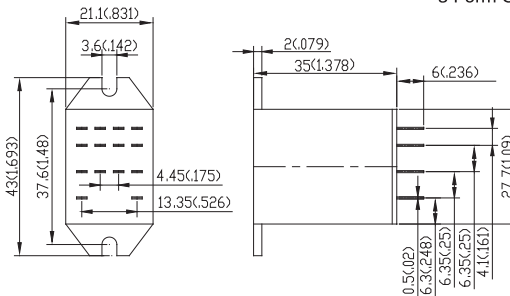

4 Form C

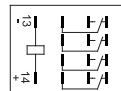
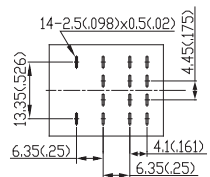
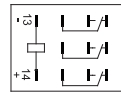
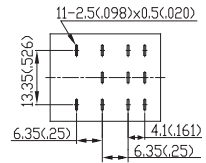
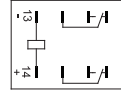
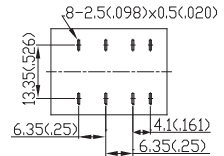

*REMARK: Dimensions $\leq 5\text{mm} \pm 0.2\text{mm}$, $> 5\text{mm} \pm 0.3\text{mm}$, the tolerance of PCB thru hole: $+0.2\text{mm}$
备注: 尺寸公差 $\leq 5\text{mm} \pm 0.2\text{mm}$, $> 5\text{mm} \pm 0.3\text{mm}$, 印刷电路板孔 $+0.2\text{mm}$

*The polarity of coil is only applied for DL, DN, DPL and DPN type 线圈极性仅适用于DL, DN, DPL 及 DPN

P.C.B Terminal 电路板式端子

Dimensions 尺寸

Internal Connections 接线图

Drilling Plan 孔位图

(Bottom View 底视图)

(Bottom View 底视图)

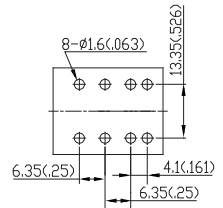
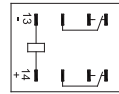
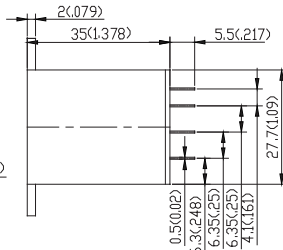
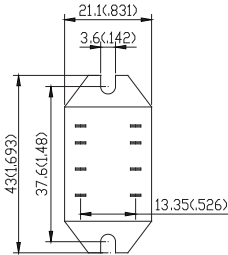

2 Form C

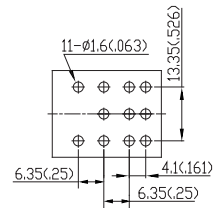
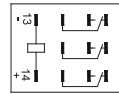
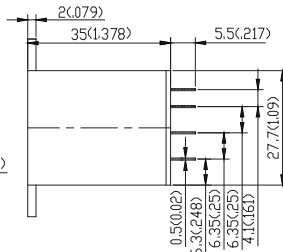
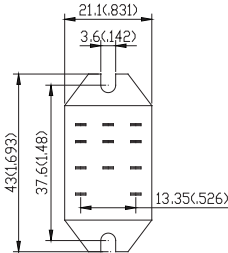

3 Form C

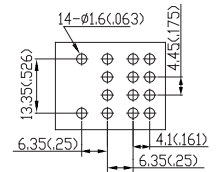
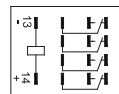
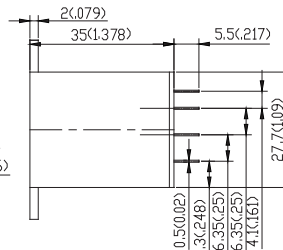
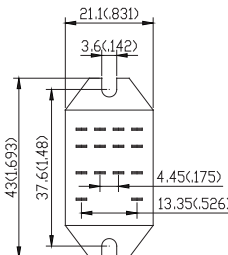

4 Form C

*REMARK: Dimensions $\leq 5\text{mm} \pm 0.2\text{mm}$, $> 5\text{mm} \pm 0.3\text{mm}$, the tolerance of PCB thru hole: $+0.2\text{mm}$

备注: 尺寸公差 $\leq 5\text{mm} \pm 0.2\text{mm}$, $> 5\text{mm} \pm 0.3\text{mm}$, 印刷电路板孔 $+0.2\text{mm}$

*The polarity of coil is only applied for DL, DN, DPL and DPN type 线圈极性仅适用于DL, DN, DPL 及 DPN

952 Reference Data 参考资料

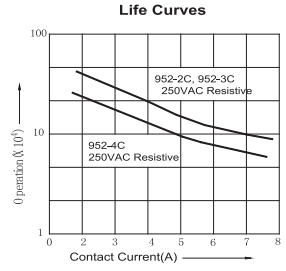
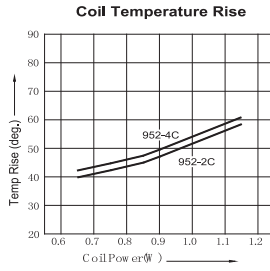
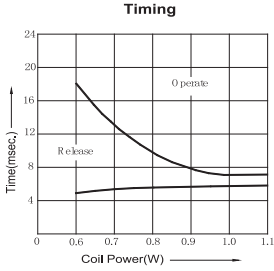

SAFETY STANDARD 安规认证

SAFETY 安规名称	Coil Voltage 线圈电压	Contact Rated 接点额定值
CQC	DC: 12V, 24V, 48V AC: 110V, 220V	7A 250VAC (952-2C/3C) 5A 250VAC (952-4C)
UL	DC: 6 ~ 110V AC: 12 ~ 240V	7A 250VAC, 7A 30VDC (952-2C/3C) 5A 250VAC, 5A 30VDC (952-4C)